

PROFESSIONAL MULTI-EFFECT PROCESSOR

SPX2000

SERVICE MANUAL



■ CONTENTS (目次)

SPECIFICATIONS (総合仕様).....	4
DIMENSIONS(寸法図)	7
PANEL LAYOUT (パネルレイアウト).....	8
CIRCUIT BOARD LAYOUT(ユニットレイアウト).....	10
DISASSEMBLY PROCEDURE(分解手順).....	11
LSI PIN DESCRIPTION(LSI 端子機能表).....	16
IC BLOCK DIAGRAM (IC ブロック図)	20
CIRCUIT BOARDS(シート基板図).....	23
INSPECTIONS(検査)	29/32
TEST PROGRAM(テストプログラム).....	35/42
WRITING PROGRAM(プログラムの書き込み).....	49
BULK OUT (ALL)	50
INITIALIZING THE SPX2000(初期化)	50
ERROR MESSAGE LIST(エラーメッセージ).....	51/52
MIDI IMPLEMENTATION CHART	53
MIDI DATA FORMAT	54
PARTS LIST	
BLOCK DIAGRAM(ブロックダイアグラム)	
OVERALL CONNECTOR CIRCUIT DIAGRAM(総コネクタ接続回路図)	
OVERALL CIRCUIT DIAGRAM (総回路図)	

IMPORTANT NOTICE

This manual has been provided for the use of authorized Yamaha Retailers and their service personnel. It has been assumed that basic service procedures inherent to the industry, and more specifically Yamaha Products, are already known and understood by the users, and have therefore not been restated.

WARNING : Failure to follow appropriate service and safety procedures when servicing this product may result in personal injury, destruction of expensive components and failure of the product to perform as specified. For these reasons, we advise all Yamaha product owners that all service required should be performed by an authorized Yamaha Retailer or the appointed service representative.

IMPORTANT : This presentation or sale of this manual to any individual or firm does not constitute authorization, certification, recognition of any applicable technical capabilities, or establish a principal-agent relationship of any form.

The data provided is believed to be accurate and applicable to the unit (s) indicated on the cover. The research engineering, and service departments of Yamaha are continually striving to improve Yamaha products. Modifications are, therefore, inevitable and changes in specification are subject to change without notice or obligation to retrofit. Should any discrepancy appear to exist, please contact the distributor's Service Division.

WARNING : Static discharges can destroy expensive components. Discharge any static electricity your body may have accumulated by grounding yourself to the ground bus in the unit (heavy gauge black wires connect to this bus).

IMPORTANT : Turn the unit OFF during disassembly and parts replacement. Recheck all work before you apply power to the unit.

WARNING : CHEMICAL CONTENT NOTICE !

The solder used in the production of this product contains LEAD. In addition, other electrical/electronic and/or plastic (where applicable) components may also contain traces of chemicals found by the California Health and Welfare Agency (and possibly other entities) to cause cancer and/or birth defects or other reproductive harm.

DO NOT PLACE SOLDER, ELECTRICAL/ELECTRONIC OR PLASTIC COMPONENTS IN YOUR MOUTH FOR ANY REASON WHAT SO EVER!

Avoid prolonged, unprotected contact between solder and your skin! When soldering, do not inhale solder fumes or expose eyes to solder/flux vapor!

If you come in contact with solder or components located inside the enclosure of this product, wash your hands before handling food.

WARNING: THIS APPARATUS MUST BE EARTHED

IMPORTANT

THE WIRES IN THIS MAINS LEAD ARE COLOURED IN ACCORDANCE WITH THE FOLLOWING CODE:

GREEN-AND-YELLOW :	EARTH
BLUE :	NEUTRAL
BROWN :	LIVE

As the colours of the wires in the mains lead of this apparatus may not correspond with the coloured markings identifying the terminals in your plug, proceed as follows:

The wire which is coloured GREEN and YELLOW must be connected to the terminal in the plug which is marked by the letter E or by the safety earth symbol  or coloured GREEN and YELLOW.

The wire which is coloured BLUE must be connected to the terminal which is marked with the letter N or coloured BLACK.

The wire which is coloured BROWN must be connected to the terminal which is marked with the letter L or coloured RED.

* This applies only to products distributed by YAMAHA KEMBLE MUSIC (U.K.) LTD.

■ WARNING

Components having special characteristics are marked  and must be replaced with parts having specification equal to those originally installed.

印の部品は、安全を維持するために重要な部品です。交換する場合は、安全のために必ず指定の部品をご使用ください。

LITHIUM BATTERY HANDLING

This product uses a lithium battery for memory back-up.

WARNING : Lithium batteries are dangerous because they can be exploded by improper handling. Observe the following precautions when handling or replacing lithium batteries.

- Leave lithium battery replacement to qualified service personnel.
- Always replace with batteries of the same type.
- When installing on the PC board by soldering, solder using the connection terminals provided on the battery cells.
- Never solder directly to the cells. Perform the soldering as quickly as possible.
- Never reverse the battery polarities when installing.
- Do not short the batteries.
- Do not attempt to recharge these batteries.
- Do not disassemble the batteries.
- Never heat batteries or throw them into fire.

ADVARSEL!

Lithiumbatteri-Eksplosionsfare ved fejlagtig handling. Udskiftning må kun ske med batteri af samme fabrikat og type. lever det brugte batteri tilbage til leverandren.

VARNING

Explosionsfara vid felaktigt batteribyte.

Använd samma batterityp eller en ekvivalent typ som rekommenderas av apparattillverkaren.

Kassera anvant batteri enligt fabrikantens instruktion.

VAROITUS

Paristo voi rajahtaa, jos se on virheellisesti asennettu.

Vaihda paristo ainoastaan laitevalmistajan suosittelemaan tyyppiin.

Havita käytetty paristo valmistajan ohjeiden mukaisesti.

The following information complies with Dutch official Gazette 1995. 45; ESSENTIALS OF ORDER ON THE COLLECTION OF BATTERIES.

- Please refer to the disassembly procedure for the removal of Back-up Battery.
- Leest u voor het verwijderen van de backup batterij deze beschrijving.

リチウム電池の取り扱い

< 注意 >

- リチウム電池を誤って交換すると爆発する危険があります。交換する場合は、サービスマニュアルで指定された部品を使用してください。

■ SPECIFICATIONS (総合仕様)

General Specifications (一般仕様)

Analog Input/Output	INPUT L,R	XLR-3-31	Balanced
		Phone jack	Balanced
	OUTPUT L,R	AD converter, 24-bit linear	128-times oversampling (@Fs=44.1, 48 kHz)
			64-times oversampling (@Fs=88.2, 96 kHz)
		Level SW	+4/-10 dBu
		XLR-3-32	Balanced
		Phone jack	Balanced
		DA converter, 24-bit linear	128-times oversampling (@Fs=44.1, 48 kHz)
	64-times oversampling (@Fs=88.2, 96 kHz)		
	Level SW	+4/-10 dBu	
Digital Input/Output	AES/EBU IN	XLR-3-31	Balanced
	AES/EBU OUT	XLR-3-32	Balanced
Controls	WORD CLOCK IN		
	MIDI IN		
	MIDI OUT/THRU		
	USB TO HOST	USB 1.1	
	INPUT L, R for VOLUME		
	FOOT SW for TAP		
Keys	[INPUT MODE], [METER], [BANK]		
	MEMORY	[UNDO], [▲], [▼], [RECALL], [STORE]	
	EDIT	[COMPARE], [▲ INC], [▼ DEC], [NEXT], [BACK]	
		[PARAMETER], [FINE], [UTILITY]	
		[BYPASS], [TAP]	
	[POWER ON/OFF]		
LEDs	Level Meter L, R	2 x 12 Segments LED	
	Effect No.	2 x 7 Segments LED	
	INPUT MODE	[MONO]/[STEREO]	
	METER	[INPUT]/[OUTPUT]	
	INPUT SOURCE	[ANALOG]/[DIGITAL]	
	CLOCK	[INT]/[AES/EBU]/[WC]	
	kHz	[96]/[88.2]/[48]/[44.1]	
	MIDI	[MIDI]	
BANK	[PRESET]/[USER]/[CLASSIC]		
LCD	16 characters x 2 rows back-lit LCD		
	Back-lit color	Green, Yellow, Magenta, Cyan, White, Red (Error Message only)	
Effects	PRESET	97	
	USER	99	
	CLASSIC	25	
Power Requirements	U.S./Canada	120V 25W 60Hz	
	Japan	100V 25W 50/60Hz	
	Others	230V 25W 50Hz	
Dimensions	Height	45 mm	
	Depth	372.5 mm	
	Width	480 mm	
Net Weight	4kg		
Operating free-air temperature range	5 — 40°C		
Storage temperature range	-20 — 60°C		
Accessories	Japan	電源コード、プラグ変換アダプター、取扱説明書、保証書	
	Others	Owner's Manual, Power cable	
Option	Foot Switch FC5		

Input/Output Characteristics (入出力特性)

Analog Input Characteristics

Input Terminals	Level SW	Input Level VR.	Actual Load Impedance	For Use With Nominal	Input Level			Connector
					Sensitivity	Nominal	Max. before clip	
INPUT L, R	+4 dBu	Max.: +10 dB	10 k Ω	600 Ω Lines	-6 dBu (0.388 V)	—	+14 dBu (3.88 V)	XLR-3-31 type (Balanced)
	-10 dBu	Max.: +10 dB			-20 dBu (0.0775 V)	—	0 dBu (0.775 V)	Phone jack (TRS: Balanced)
Input Terminals	Level SW	Input Level VR.	Actual Load Impedance	For Use With Nominal	Input Level			Connector
					Sensitivity	Nominal	Max. before clip	
INPUT L, R	+4 dBu	Nominal: 0 dB	10 k Ω	600 Ω Lines	—	+4 dBu (1.23 V)	+24 dBu (12.28 V)	XLR-3-31 type (Balanced)
	-10 dBu	Nominal: 0 dB			—	-10 dBu (0.245 V)	+10 dBu (2.45 V)	Phone jack (TRS: Balanced)

- *1 Sensitivity is the lowest level that will produce an output of +4dB(1.23V) or the nominal output level when the unit is set to maximum gain. (level control is maximum position.)
- *2 XLR-3-31 type connectors are balanced. (1=GND, 2=HOT, 3=COLD)
- *3 Phone jacks are balanced. (Tip=HOT, Ring=COLD, Sleeve=GND)
- *4 In these specifications, when dBu represents are specific voltage, 0 dBu is referenced to 0.775 Vrms.
- *5 AD converter is 24-bit linear, 128-times oversampling @Fs=44.1, 48 kHz, 64-times oversampling @Fs=88.2, 96 kHz

Analog Output Characteristics

Output Terminals	Actual Source Impedance	For Use With Nominal	Level SW	Output Level		Connector
				Nominal	Max. before clip	
OUTPUT L, R	150 Ω	600 Ω Lines	+4 dBu	+4 dBu (1.23 V)	+24 dBu (12.28 V)	XLR-3-31 type (Balanced) Phone jack (TRS: Balanced)
			-10 dBu	-10 dBu (0.245 V)	+10 dBu (2.45 V)	

- *1 XLR-3-32 type connectors are balanced. (1=GND, 2=HOT, 3=COLD)
- *2 Phone jacks are balanced. (Tip=HOT, Ring=COLD, Sleeve=GND)
- *3 In these specifications, when dBu represents are specific voltage, 0 dBu is referenced to 0.775 Vrms.
- *4 DA converter is 24-bit, 128-times oversampling @Fs=44.1, 48 kHz, 64-times oversampling @Fs=88.2, 96 kHz

Digital Input Characteristics

Input Terminals	Format	Data Length	Level	Connector
AES/EBU IN	AES/EBU	24-bit	RS422	XLR-3-31 type (Balanced)

- *1 XLR-3-31 type connectors are balanced. (1=GND, 2=HOT, 3=COLD)

Digital Output Characteristics

Input Terminals	Format	Data Length	Level	Connector
AES/EBU OUT	AES/EBU Professional use	24-bit	RS422	XLR-3-31 type (Balanced)

- *1 channel status of AES/EBU OUT
type: 2 audio channels
emphasis: NO
sampling frequency: depends on the internal configuration
- *2 dither: word length 16 - 24-bit
- *3 XLR-3-32 type connector is balanced. (1=GND, 2=HOT, 3=COLD)

Control I/O Characteristics

Terminals		Format	Level	Connector
USB	TO HOST	USB 1.1	0 to 3.3 V	B type USB Connector
MIDI	IN	MIDI	—	DIN Connector 5P
	OUT/THRU	MIDI	—	DIN Connector 5P
WORD CLOCK	IN	—	TTL/75 Ω	BNC Connector

Electrical Characteristics(電気的特性)

Input Level VR is nominal when measured. Output impedance of signal generator:600ohms

Frequency Response

F_s=48 kHz: @20 Hz-20 kHz, reference to the nominal output level @1 kHz

F_s=96 kHz: @20 Hz-40 kHz, reference to the nominal output level @1 kHz

Input	Output	RL	Conditions	Min	Typ	Max	Units
INPUT L, R	OUTPUT L, R	600 Ω	—	-3.0	0.0	+1.0	dB

Gain Error

@1 kHz

Input	Output	RL	Conditions	Min	Typ	Max	Units
INPUT L, R	OUTPUT L, R	600 Ω	INPUT LEVEL SW: +4, OUTPUT LEVEL SW: +4	+2.0	+4.0	+6.0	dBu
			INPUT LEVEL SW: -10, OUTPUT LEVEL SW: -10	-12.0	-10.0	-8.0	dBu

*1 In these specifications, when dBu represents are specific voltage, 0 dBu is referenced to 0.775 V_{rms}.

Total Harmonic Distortion

Input	Output	RL	Conditions	Min	Typ	Max	Units
INPUT L, R	OUTPUT L, R	600 Ω	F _s =48 kHz: +14 dBu @20 Hz-20 kHz, INPUT LEVEL SW: +4, OUTPUT LEVEL SW: +4			0.05	%
			F _s =96 kHz: +14 dBu @20 Hz-40 kHz, INPUT LEVEL SW: +4, OUTPUT LEVEL SW: +4			0.05	%

*1 In these specifications, when dBu represents are specific voltage, 0 dBu is referenced to 0.775 V_{rms}.

*2 Total Harmonic Distortion is measured with a 18 dB/octave filter @80 kHz.

Hum & Noise

F_s=48/96 kHz

Input	Output	RL	Conditions	Min	Typ	Max	Units
INPUT L, R	OUTPUT L, R	600 Ω	R _s =600 Ω, INPUT LEVEL VR: nominal INPUT LEVEL SW: +4 /OUTPUT LEVEL SW: +4			-80	dBu

*1 Hum & Noise are measured with a 6 dB/octave filter @12.7 kHz;
equivalent to a 20 kHz filter with infinite dB/octave attenuation.

*2 In these specifications, when dBu represents are specific voltage, 0 dBu is referenced to 0.775 V_{rms}.

Dynamic Range

F_s=48/96 kHz

Input	Output	RL	Conditions	Min	Typ	Max	Units
INPUT L, R	OUTPUT L, R	600 Ω	AD + DA, INPUT LEVEL VR: max		106		dB

*1 Dynamic range are measured with a 6 dB/octave filter @12.7 kHz;
equivalent to a 20 kHz filter with infinite dB/octave attenuation.

Crosstalk

@1 kHz

Input	Output	Conditions	Min	Typ	Max	Units
INPUT L, R	OUTPUT L, R	INPUT to OUTPUT			-80	dB

Maximum voltage gain

@1 kHz

Input	Output	RL	Conditions	Min	Typ	Max	Units
INPUT L, R	OUTPUT L, R	600 Ω	R _s =600 Ω, INPUT LEVEL VR: nominal INPUT LEVEL SW: +4 /OUTPUT LEVEL SW: +4		+10		dB

PARAMETER		CONDITIONS	MIN	TYP	MAX	UNITS
Sampling Frequency						
External Clock	Frequency Range	Normal Rate	39.69		50.88	kHz
		Double Rate	79.38		101.76	kHz
	Jitter of PLL	DIGITAL IN Fs=44.1 kHz, Jitter ≤ 2ns			10	ns
		DIGITAL IN Fs=48 kHz, Jitter ≤ 2ns			10	ns
		DIGITAL IN Fs=39.69-50.88 kHz, Jitter ≤ 2ns			20	ns
		DIGITAL IN Fs=88.2 kHz, Jitter ≤ 2ns			10	ns
		DIGITAL IN Fs=96 kHz, Jitter ≤ 2ns			10	ns
DIGITAL IN Fs=79.38-101.76 kHz, Jitter ≤ 2ns			20	ns		
Internal Clock	Frequency	word clock: int 44.1 kHz		44.1		kHz
		word clock: int 48 kHz		48		kHz
		word clock int 88.2 kHz		88.2		kHz
		word clock: int 96 kHz		96		kHz
	accuracy	word clock int 44.1 kHz			50	ppm
		word clock: int 48 kHz			50	ppm
		word clock: int 88.2 kHz			50	ppm
		word clock: int 96 kHz			50	ppm
	jitter	word clock: int 44.1 kHz			5	ns
		word clock: int 48 kHz			5	ns
		word clock : int 88.2 kHz			5	ns
		word clock: int 96 kHz			5	ns
	Signal Delay		INPUT to OUTPUT (@Delay time=0.0 ms / Fs=96 kHz)			426
Idle tone		AD converter, peak@20 Hz~20 kHz	-130			dB

■ DIMENSIONS(寸法図)

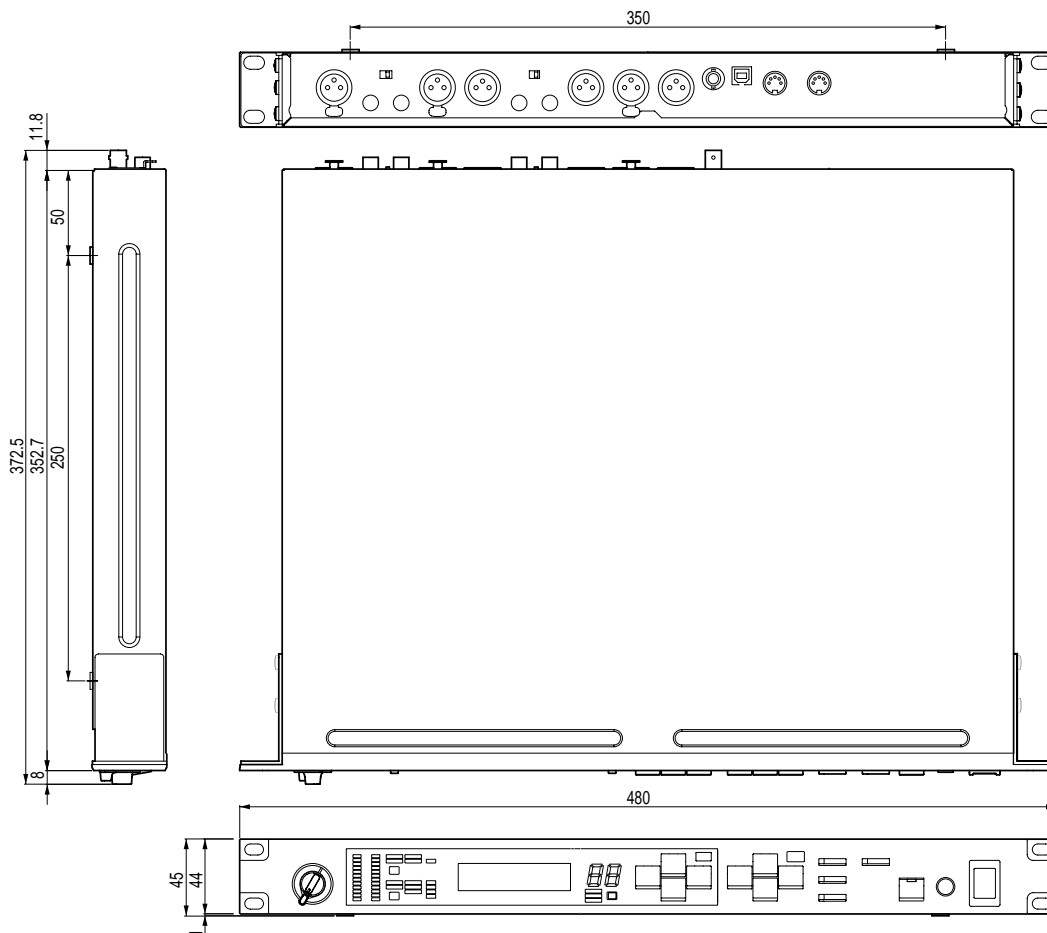

Units : mm
(単位)

■ PANEL LAYOUT (パネルレイアウト)

■ Front Panel (フロントパネル)

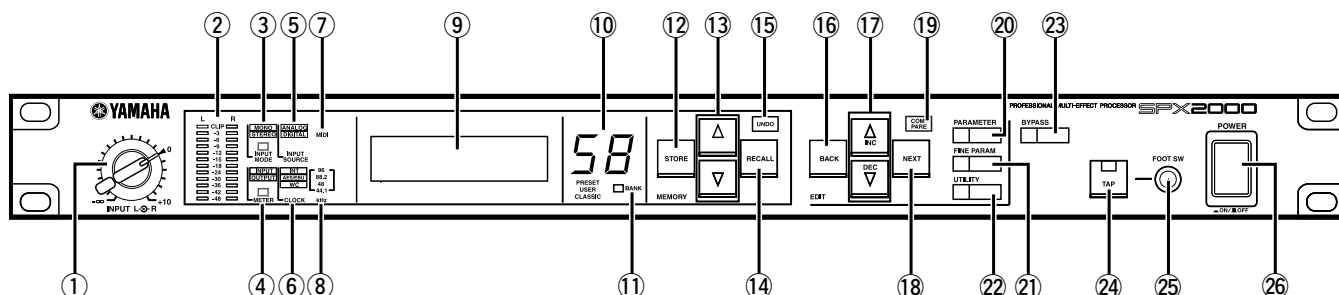

- | | |
|---------------------------------|----------------------------|
| ① [INPUT L ↔ R] control | ① [INPUT L ↔ R]コントロール |
| ② Level meters | ② レベルメーター |
| ③ [INPUT MODE] button/indicator | ③ [INPUT MODE] ボタン/インジケーター |
| ④ [METER] button/indicator | ④ [METER] ボタン/インジケーター |
| ⑤ [INPUT SOURCE] indicator | ⑤ [INPUT SOURCE]インジケーター |
| ⑥ [CLOCK] indicator | ⑥ [CLOCK]インジケーター |
| ⑦ [MIDI] indicator | ⑦ [MIDI]インジケーター |
| ⑧ [kHz] indicator | ⑧ [kHz]インジケーター |
| ⑨ Display | ⑨ ディスプレイ |
| ⑩ Effect number indicator | ⑩ エフェクト番号インジケーター |
| ⑪ [BANK] button/indicator | ⑪ [BANK] ボタン/インジケーター |
| ⑫ [STORE] button | ⑫ [STORE]ボタン |
| ⑬ [▲]/[▼] buttons | ⑬ [▲]/[▼]ボタン |
| ⑭ [RECALL] button | ⑭ [RECALL]ボタン |
| ⑮ [UNDO] button/LED | ⑮ [UNDO] ボタン/LED |
| ⑯ [BACK] button | ⑯ [BACK]ボタン |
| ⑰ [▲ INC]/[▼ DEC] buttons | ⑰ [▲ INC]/[▼ DEC]ボタン |
| ⑱ [NEXT] button | ⑱ [NEXT]ボタン |
| ⑲ [COMPARE] button/LED | ⑲ [COMPARE] ボタン/LED |
| ⑳ [PARAMETER] button/LED | ⑳ [PARAMETER] ボタン/LED |
| ㉑ [FINE PARAM] button/LED | ㉑ [FINE PARAM] ボタン/LED |
| ㉒ [UTILITY] button/LED | ㉒ [UTILITY] ボタン/LED |
| ㉓ [BYPASS] button/LED | ㉓ [BYPASS] ボタン/LED |
| ㉔ [TAP] button/LED | ㉔ [TAP] ボタン/LED |
| ㉕ [FOOT SW] jack | ㉕ [FOOT SW]端子 |
| ㉖ [POWER ON/OFF] button | ㉖ [POWER ON/OFF]ボタン |

■ Rear Panel(リアパネル)

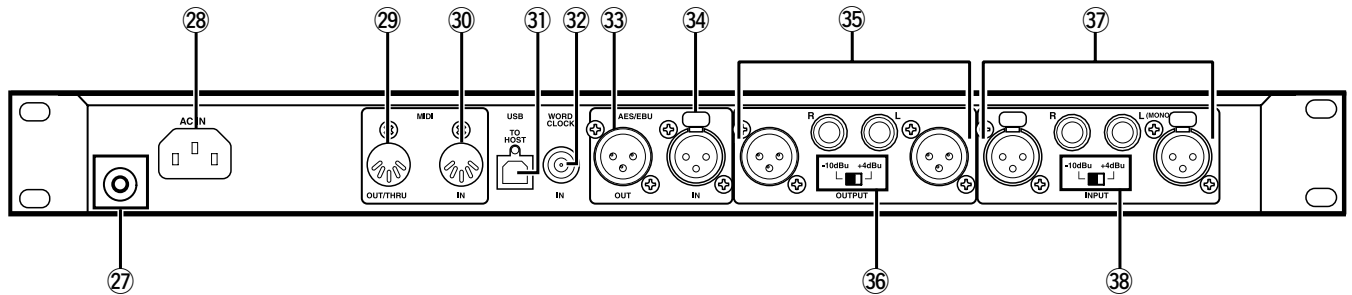

②⑦ Grounding screw

②⑧ [AC IN] jack

②⑨ [MIDI OUT/THRU] connector

③⑩ [MIDI IN] connector

③① [TO HOST USB] connector

③② [WORD CLOCK IN] jack

③③ [AES/EBU OUT] jack

③④ [AES/EBU IN] jack

③⑤ [OUTPUT] jacks

③⑥ [OUTPUT -10 dBu/+4 dBu] switch

③⑦ [INPUT] jacks

③⑧ [INPUT -10 dBu/+4 dBu] switch

②⑦ アース用ネジ

②⑧ [AC IN]端子

②⑨ [MIDI OUT/THRU]端子

③⑩ [MIDI IN]端子

③① [TO HOST USB]端子

③② [WORD CLOCK IN]端子

③③ [AES/EBU OUT]端子

③④ [AES/EBU IN]端子

③⑤ [OUTPUT]端子

③⑥ [OUTPUT -10dBu/+4dBu]スイッチ

③⑦ [INPUT]端子

③⑧ [INPUT -10dBu/+4dBu]スイッチ

■ CIRCUIT BOARD LAYOUT(ユニットレイアウト)

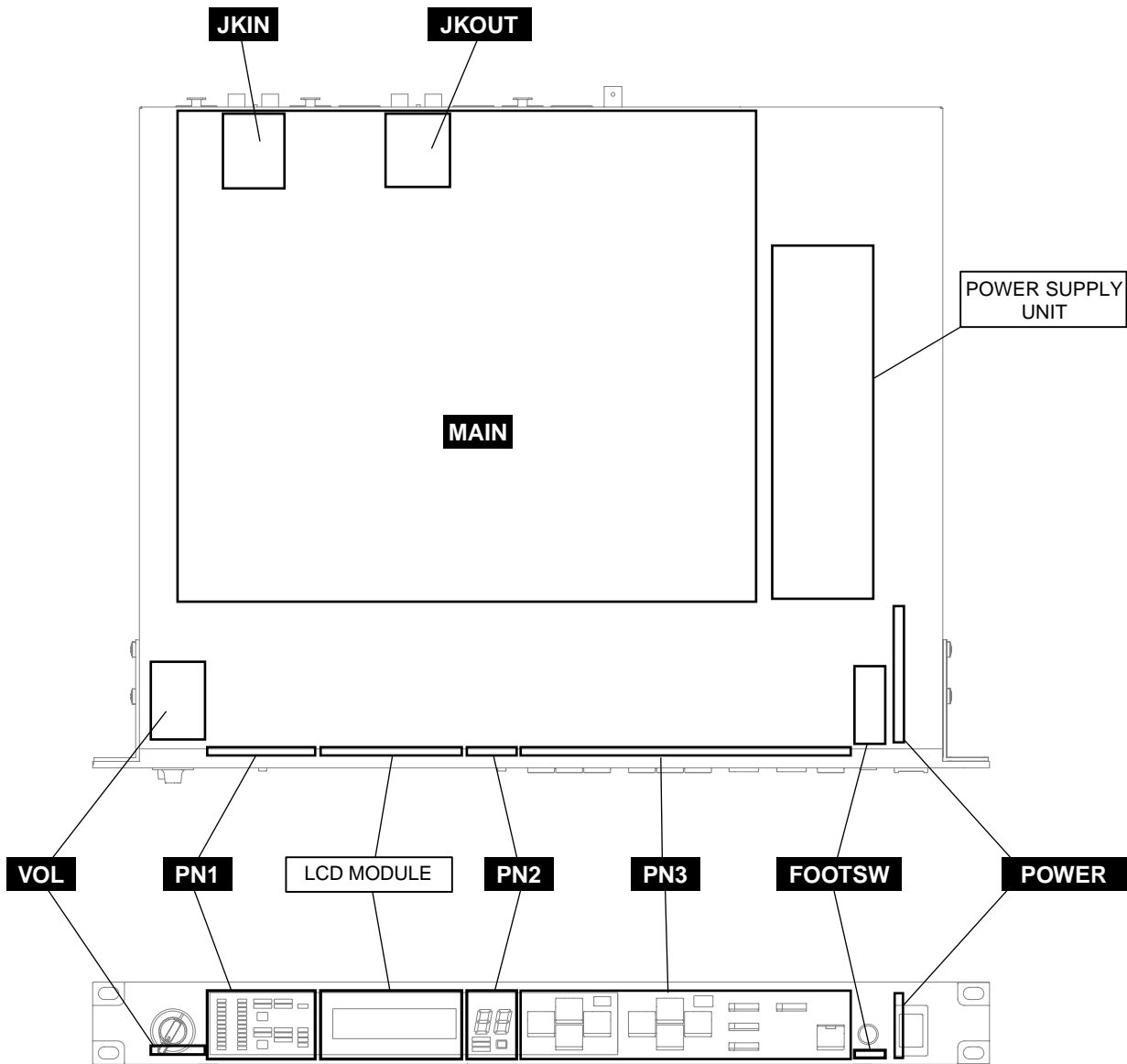

■ DISASSEMBLY PROCEDURE (分解手順)

1. Rack Angle

(Time required : About 1 min.)

- 1-1. Remove the three (3) screws marked [540A]. The rack angle L can then be removed. (Fig. 1)
- 1-2. Remove the three (3) screws marked [540B]. The rack angle R can then be removed. (Fig. 1)

1. ラックアングル (所要時間:約1分)

- 1-1. [540A]のネジ3本を外し、ラックアングルLを外します。(図1)
- 1-2. [540B]のネジ3本を外し、ラックアングルRを外します。(図1)

2. Top Cover

(Time required : About 2 min.)

- 2-1. Remove the rack angle L and R. (See procedure 1)
- 2-2. Remove the nine (9) screws marked [520]. The top cover can then be removed. (Fig. 1)

2. トップカバー (所要時間:約2分)

- 2-1. ラックアングルL、Rを外します。(1項参照)
- 2-2. [520]のネジ9本を外し、トップカバーを外します。(図1)

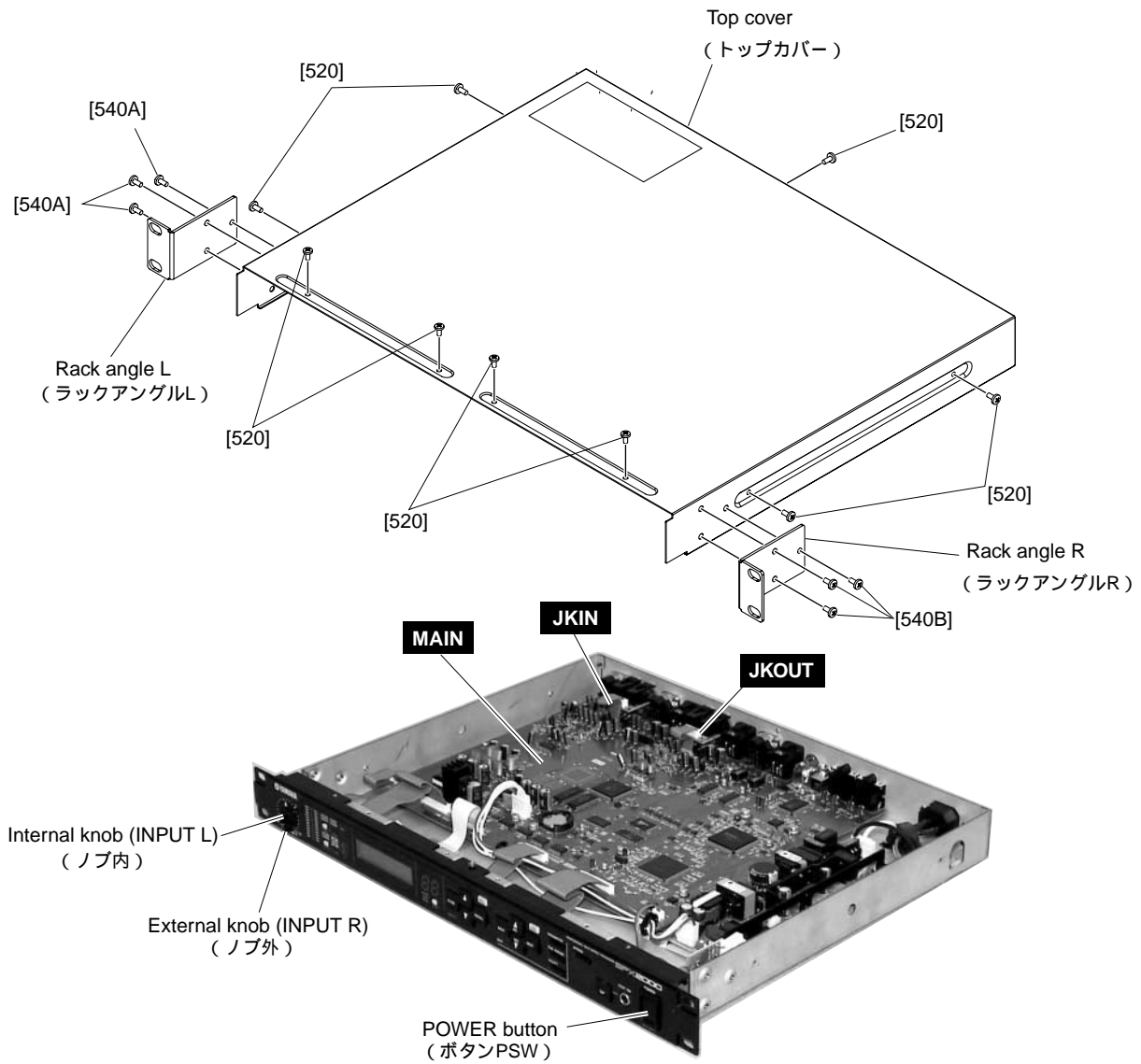

[520]: Bind Head Tapping Screw-S	3.0 x 6	MFZN2BL	(EP630210)	+ バインドSタイト
[540]: Bind Head Tapping Screw-S	4.0 x 8	MFZN2BL	(VI693100)	+ バインドSタイト

(Fig. 1)
(図1)

3. Front Panel

(Time required : About 3 min.)

- 3-1. Remove the rack angle L and R. (See procedure 1)
- 3-2. Remove the top cover. (See procedure 2)
- 3-3. Pull out the internal knob (INPUT L) and the external knob (INPUT R). (Fig. 1)
- 3-4. Remove the screw marked [420] and three (3) screws marked [430]. The front panel can then be removed. (Fig. 2)

- 3. フロントパネル (所要時間:約3分)
- 3-1. ラックアングルL、Rを外します。(1項参照)
- 3-2. トップカバーを外します。(2項参照)
- 3-3. ノブ内 (INPUT L) とノブ外 (INPUT R) を外します。(図1)
- 3-4. [420]のネジ1本と[430]のネジ3本を外し、フロントパネルを外します。(図2)

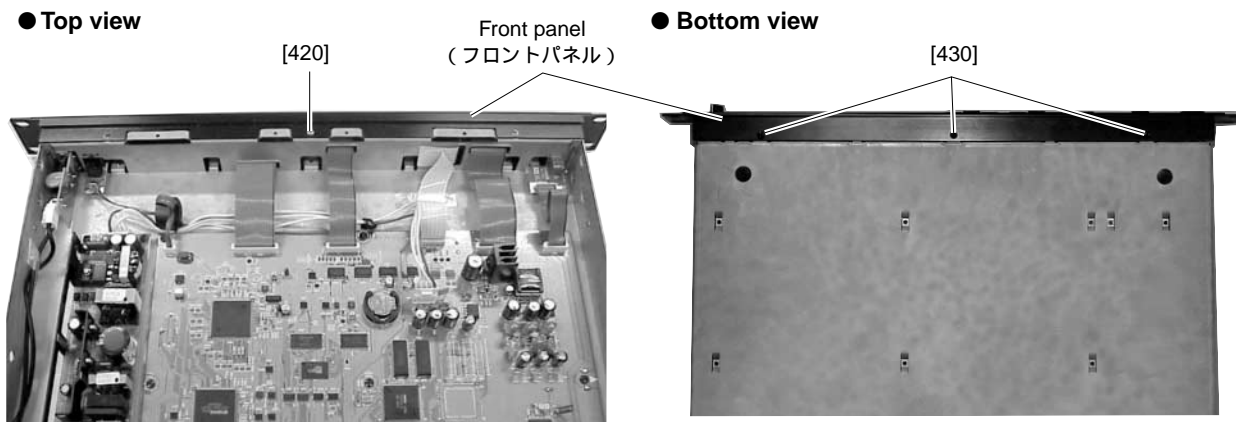

[420]: Flat Head Tapping Screw-S	3.0 x 6	MFAN2Y	(WB451000)	Sタイト平頭
[430]: Bind Head Tapping Screw-S	3.0 x 6	MFZN2BL	(EP630210)	+ バインドSタイト

(Fig. 2)
(図2)

4. JKIN Circuit Board, JKOUT Circuit Board

(Time required : About 3 minutes each.)

- 4-1. Remove the rack angle L and R. (See procedure 1)
- 4-2. Remove the top cover. (See procedure 2)
- 4-3. Remove the two (2) hexagonal nuts marked [130A]. The JKIN circuit board can then be removed. (Fig. 3)
- 4-4. Remove the two (2) hexagonal nuts marked [130B]. The JKOUT circuit board can then be removed. (Fig. 3)

- 4. JKIN、JKOUTシート (所要時間:各約3分)
- 4-1. ラックアングルL、Rを外します。(1項参照)
- 4-2. トップカバーを外します。(2項参照)
- 4-3. [130A]の特殊六角ナット2個を外し、JKINシートを外します。(図3)
- 4-4. [130B]の特殊六角ナット2個を外し、JKOUTシートを外します。(図3)

● Rear view

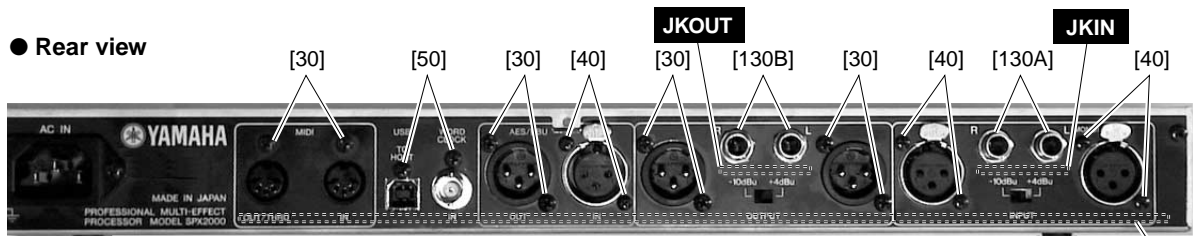

[30]: Bind Head Tapping Screw-B	3.0 x 8	MFZN2BL	(EP600190)	+ バインドBタイト
[40]: Bind Head Tapping Screw-B	2.6 x 8	MFZN2BL	(VB096700)	+ バインドBタイト
[50]: Bind Head Tapping Screw-S	3.0 x 6	MFZN2BL	(EP630210)	+ バインドSタイト
[130]: Hexagonal Nut	9.0 x 11		(V2431400)	特殊六角ナット

(Fig. 3)
(図3)

5. MAIN Circuit Board

(Time required : About 5 min.)

- 5-1. Remove the rack angle L and R. (See procedure 1)
- 5-2. Remove the top cover. (See procedure 2)
- 5-3. Remove the JKIN circuit board and JKOUT circuit board. (See procedure 4)
- 5-4. Remove the eight (8) screws marked [30], the six (6) screws marked [40] and the two (2) screws marked [50]. (Fig. 3)
- 5-5. Remove the eight (8) screws marked [60]. The MAIN circuit board can then be removed. (Fig. 4)

6. Replacing the Lithium Battery

(Time required : About 3 min.)

- 6-1. Remove the rack angle L and R. (See procedure 1)
- 6-2. Remove the top cover. (See procedure 2)
- 6-3. You can replace the lithium battery from the MAIN circuit board. (Fig. 4)
- * **The lithium battery is not part of the MAIN circuit board. When you replace the MAIN circuit board, you should remove the lithium battery from the board, and install in the holder on the new circuit board.**
- * **Important data should be backed up by BULK OUT (ALL) function. (See page 50.)**

7. Power Supply Unit

(Time required : About 3 min.)

- 7-1. Remove the rack angle L and R. (See procedure 1)
- 7-2. Remove the top cover. (See procedure 2)
- 7-3. Remove the four (4) screws marked [100]. The power supply unit can then be removed. (Fig. 4)

5. MAINシート (所要時間:約5分)

- 5-1. ラックアングルL、Rを外します。(1項参照)
- 5-2. トップカバーを外します。(2項参照)
- 5-3. JKINシート、JKOUTシートを外します。(4項参照)
- 5-4. [30]のネジ8本、[40]のネジ6本、[50]のネジ2本を外します。(図3)
- 5-5. [60]のネジ8本を外し、MAINシートを外します。(図4)

6. リチウム電池の交換 (所要時間:約3分)

- 6-1. ラックアングルL、Rを外します。(1項参照)
- 6-2. トップカバーを外します。(2項参照)
- 6-3. MAINシート上より、リチウム電池を交換することができます。(図4)
リチウム電池は、MAINシートの構成部品ではありません。MAINシートを交換する際には、本体のシートからリチウム電池を取り外して、新しいシートに取り付けてください。重要なデータは、あらかじめ「BULK OUT (ALL)」機能でバックアップしてください。(50ページ参照)

7. 電源ユニット (所要時間:約3分)

- 7-1. ラックアングルL、Rを外します。(1項参照)
- 7-2. トップカバーを外します。(2項参照)
- 7-3. [100]のネジ4本を外し、電源ユニットを外します。(図4)

● Lithium Battery (リチウム電池)

Battery VN103500
VN103600(Battery holder for VN103500)

- Notice for back-up battery removal
Push the battery as shown in figure, then the battery will pop up.
- Druk de batterij naar beneden zoals aangeven in de tekening, de batterij springt dan naar voren.

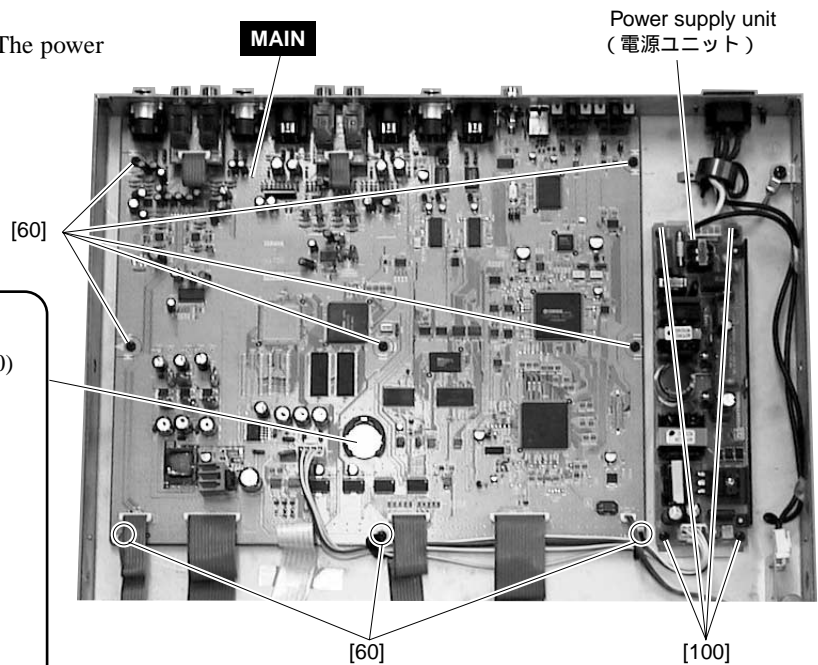
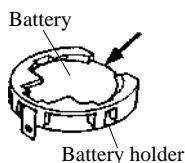

[60]:	Bind Head Tapping Screw-S + バインドSタイト	3.0 x 6	MFZN2BL	(EP630210)
[100]:	Bind Head Tapping Screw-S + バインドSタイト	3.0 x 6	MFZN2BL	(EP630210)

(Fig. 4)
(図4)

8. VOL Circuit Board, FOOT SW Circuit Board, POWER Circuit Board

(Time required : About 4 minutes each.)

- 8-1. Remove the rack angle L and R. (See procedure 1)
- 8-2. Remove the top cover. (See procedure 2)
- 8-3. Remove the front panel. (See procedure 3)
- 8-4. **VOL Circuit Board**
Remove the nut and the washer. The VOL circuit board can then be removed. (Fig. 5)
- 8-5. **FOOT SW Circuit Board**
Remove the screw marked [360] and the hexagonal nut marked [350]. The FOOT SW circuit board can then be removed. (Fig. 5)
- 8-6. **POWER Circuit Board**
8-6-1. Pull out the POWER button from the POWER circuit board.
8-6-2. Remove the two (2) screws marked [380]. The POWER circuit board can then be removed. (Fig. 5)

9. PN1 Circuit Board, PN2 Circuit Board, PN3 Circuit Board, LCD

(Time required : About 5 minutes each.)

- 9-1. Remove the rack angle L and R. (See procedure 1)
- 9-2. Remove the top cover. (See procedure 2)
- 9-3. Remove the front panel. (See procedure 3)
- 9-4. Remove the two (2) screws marked [300]. The LED guide can then be removed. (Fig. 5)

8. VOLシート、FOOT SWシート、POWERシート

(所要時間:各約4分)

- 8-1. ラックアングルL、Rを外します。(1項参照)
- 8-2. トップカバーを外します。(2項参照)
- 8-3. フロントパネルを外します。(3項参照)
- 8-4. VOLシート
ナットとワッシャーを外し、VOLシートを外します。(図5)
- 8-5. FOOT SWシート
[360]のネジ1本と[350]の特殊六角ナット1個を外し、FOOT SWシートを外します。(図5)
- 8-6. POWERシート
8-6-1. POWERシートからボタンPSWを抜き取ります。
8-6-2. [380]のネジ2本を外し、POWERシートを外します。(図5)

9. PN1シート、PN2シート、PN3シート、LCD

(所要時間:各約5分)

- 9-1. ラックアングルL、Rを外します。(1項参照)
- 9-2. トップカバーを外します。(2項参照)
- 9-3. フロントパネルを外します。(3項参照)
- 9-4. [300]のネジ2本を外し、LEDガイドを外します。(図5)

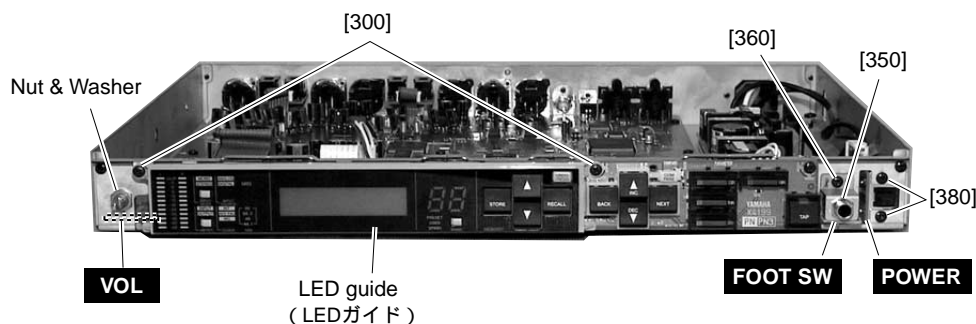

[300]: Bind Head Tapping Screw-S	3.0 x 10	MFZN2Y	(EP630630) + バインドタイト
[350]: Hexagonal Nut	9.0 x 11		(V2431400) 特殊六角ナット
[360]: Bind Head Tapping Screw-S	3.0 x 6	MFZN2BL	(EP630210) + バインドタイト
[380]: Bind Head Tapping Screw-S	3.0 x 6	MFZN2BL	(EP630210) + バインドタイト

(Fig. 5)
(図5)

- 9-5. Remove the three (3) hooks from the LED guide. The PN1 circuit board can then be removed. (Fig. 6)
- 9-6. Remove the two (2) hooks from the LED guide. The PN2 circuit board can then be removed. (Fig. 6)
- 9-7. Remove the four (4) hooks from the LED guide. The LCD can then be removed. (Fig. 6)
- 9-8. Remove the two (2) screws marked [200]. The PN3 circuit board can then be removed. (Fig. 7)

- 9-5. フック3箇所を外し、LEDガイドからPN1シートを外します。(図6)
- 9-6. フック2箇所を外し、LEDガイドからPN2シートを外します。(図6)
- 9-7. フック4箇所を外し、LEDガイドからLCDを外します。(図6)
- 9-8. [200]のネジ2本を外し、PN3シートを外します。(図7)

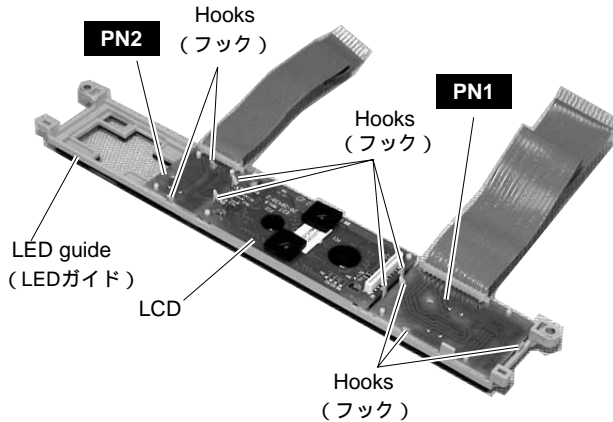

(Fig. 6)
(図6)

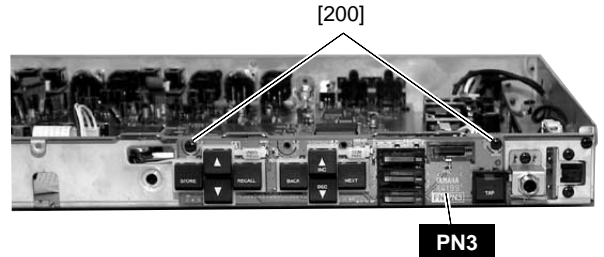

[200]: Bind Head Tapping Screw-S 3.0 x 6 MFZN2BL (EP630210)
+ バインドSタイト

(Fig. 7)
(図7)

10. AC Inlet Assembly

(Time required : About 3 min.)

- 10-1. Remove the rack angle L and R. (See procedure 1)
- 10-2. Remove the top cover. (See procedure 2)
- 10-3. Remove the two (2) screws marked [150], the screw marked [160] and the cord holder marked [170]. The AC inlet assembly can then be removed. (Fig. 8)

- 10. ACインレットAss'y (所要時間:約3分)
- 10-1. ラックアングルL、Rを外します。(1項参照)
- 10-2. トップカバーを外します。(2項参照)
- 10-3. [150]のネジ2本、[160]のネジ1本、[170]のインシュロックタイ1本を外し、ACインレットAss'yを外します。(図8)

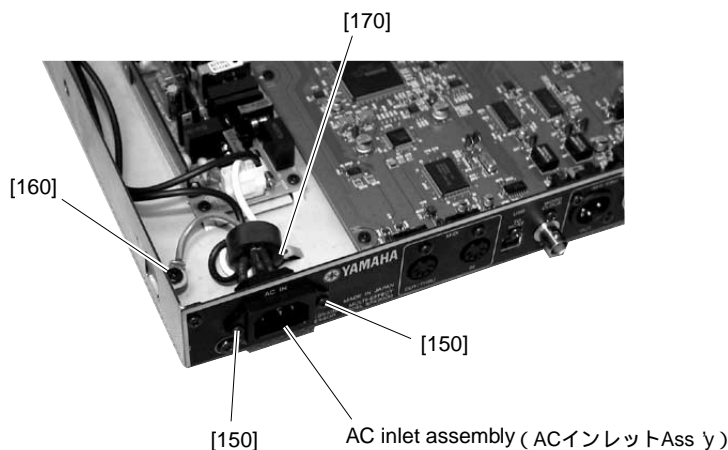

[150]: Bind Head Tapping Screw-B	3.0 x 8	MFZN2BL	(EP600190)	+ バインドBタイト
[160]: Bind Head Screw	4.0 x 8	MFZN2BL	(EG340360)	+ バインド小ネジ
[170]: Cord Holder	BK-1		(CB069250)	インシュロックタイ

(Fig. 8)
(図8)

■ LSI PIN DESCRIPTION(LSI 端子機能表)

AK4393-VF-E2 (XW029A00) DAC (Digital to Analog Converter)	20
CS5361-KS (X3447A00) ADC (Analog to Digital Converter)	20
CS8405A-CS (XZ349A00) DIT (Digital Audio Interface Transmitter)	19
CS8415A-CS (X2089A00) DIR (Digital Audio Interface Receiver)	19
HD6417709SF133 (X2081A00) CPU (SH3)	17
M37641M8-141FP (X2485200) CPU (USB 32K)	16
YM3436DK (XG948E00) DIR2 (Digital Format Interface Receiver)	19
YSS910-S (XV988A00) DSP6 (Digital Signal Processor)	18

● M37641M8-141FP (X2485200) CPU (USB 32K)

MAIN: IC407

PIN NO.	NAME	I/O	FUNCTION	PIN NO.	NAME	I/O	FUNCTION	
1	P6 ₁ /DQ ₁	I/O	} Port 6	41	P1 ₇ /AB ₁₅	I/O	} Port 1	
2	P6 ₀ /DQ ₀	I/O		42	P1 ₆ /AB ₁₄	I/O		
3	P5 ₇ //W/(R/W)	I/O	} Port 5	43	P1 ₅ /AB ₁₃	I/O		
4	P5 ₆ //R(E)	I/O		44	P1 ₄ /AB ₁₂	I/O		
5	P5 ₅ /A ₀	I/O		45	P1 ₃ /AB ₁₁	I/O		
6	P5 ₄ //S ₀	I/O		46	P1 ₂ /AB ₁₀	I/O		
7	P5 ₃ //IBF ₀	I/O	47	P1 ₁ /AB ₉	I/O	} Port 0		
8	P5 ₂ /OBF ₀	I/O	48	P1 ₀ /AB ₈	I/O			
9	CNV _{SS} /V _{PP}	I	Chip operation mode	49	P0 ₇ /AB ₇	I/O		} Port 2
10	/RESET	I	Reset input	50	P0 ₆ /AB ₆	I/O		
11	P5 ₁ /TOUT/XCOUT	I/O	} Port 5	51	P0 ₅ /AB ₅	I/O		
12	P5 ₀ /XCIN	I/O		52	P0 ₄ /AB ₄	I/O		
13	V _{SS}		Ground	53	P0 ₃ /AB ₃	I/O	} Port 7	
14	X _{IN}	I	Quartz crystal input	54	P0 ₂ /AB ₂	I/O		
15	X _{OUT}	O	Quartz crystal output	55	P0 ₁ /AB ₁	I/O	} Port 6	
16	V _{CC}		Power supply +5V	56	P0 ₀ /AB ₀	I/O		
17	AV _{CC}		Analog power supply +5V	57	P2 ₇ /DB ₇	I/O		
18	LPF	O	Loop filter for synthesizer	58	P2 ₆ /DB ₆	I/O		
19	AV _{SS}		Analog ground	59	P2 ₅ /DB ₅	I/O	} Port 3	
20	P4 ₄ /CNTR ₁	I/O	} Port 4	60	P2 ₄ /DB ₄	I/O		
21	P4 ₃ /CNTR ₀	I/O		61	P2 ₃ /DB ₃	I/O		
22	P4 ₂ /INT ₁	I/O		62	P2 ₂ /DB ₂	I/O		
23	P4 ₁ /INT ₀	I/O		63	P2 ₁ /DB ₁	I/O		
24	P4 ₀ /EDMA	I/O	64	P2 ₀ /DB ₀	I/O	} Port 8		
25	P8 ₇ //RTS ₁	I/O	65	P7 ₄ /OBF ₁	I/O			
26	P8 ₆ //CTS ₁	I/O	} Port 8	66	P7 ₃ //IBF//HLDA	I/O		
27	P8 ₅ //URXD ₁	I/O		67	P7 ₂ //S ₁	I/O		
28	P8 ₄ //UTXD ₁	I/O		68	P7 ₁ //HOLD	I/O		
29	P8 ₃ //RTS ₂ /STXD	I/O		69	P7 ₀ //SOF	I/O		
30	P8 ₂ //CTS ₂ /SRXD	I/O	70	USB D+	I/O	USB +voltage line interface		
31	P8 ₁ //URXD ₂ /SCLK	I/O	71	USB D-	I/O	USB -voltage line interface		
32	P8 ₀ //UTXD ₂ /SRDY	I/O	72	Ext. Cap	I/O	Power supply +3.3V		
33	P3 ₇ //RD	I/O	} Port 3	73	V _{SS}		Ground	
34	P3 ₆ //WR	I/O		74	V _{CC}		Power supply +5V	
35	P3 ₅ /SYN _{COUT}	I/O		75	P6 ₇ /DQ ₇	I/O	} Port 6	
36	P3 ₄ /Ø _{OUT}	I/O		76	P6 ₆ /DQ ₆	I/O		
37	P3 ₃ /DMA _{OUT}	I/O		77	P6 ₅ /DQ ₅	I/O		
38	P3 ₂	I/O		78	P6 ₄ /DQ ₄	I/O		
39	P3 ₁	I/O		79	P6 ₃ /DQ ₃	I/O		
40	P3 ₀ /RDY	I/O		80	P6 ₂ /DQ ₂	I/O		

● HD6417709SF133 (X2081A00) CPU (SH3)

MAIN: IC004

PIN NO.	NAME	I/O	FUNCTION	PIN NO.	NAME	I/O	FUNCTION	
1	MD1	I	Mode control	105	CKE/PTK5	I/O	CK enable / Port K	
2	MD2	I		106	RAS3L/PTJ0	I/O	RAS address bus / Port J	
3	Vcc(RTC)	-	Power supply +1.8 V	107	PTJ1	I/O	Port J	
4	XTAL2	O	Crystal oscillator	108	CASL/PTJ2	I/O	CAS address bus / Port J	
5	EXTAL2	O		109	VssQ	-	Ground	
6	Vss(RTC)	-	Ground	110	CASU/PTJ3	I/O	CAS address bus / Port J	
7	NMI	I	Non-maskable interrupt request	111	VccQ	-	Power supply +3.3 V	
8	IRQ0/IRL0/PTH0	I	Interrupt request / Port H	112	PTJ4	I/O	Port J	
9	IRQ1/IRL1/PTH1	I		113	PTJ5	I/O	Port J	
10	IRQ2/IRL2/PTH2	I		114	DACK0/PTD5	I/O	DMA acknowledge / Port D	
11	IRQ3/IRL3/PTH3	I		115	DACK1/PTD7	I/O		
12	IRQ4/PTH4	I		116	PTE6	I/O	Port E	
13	D31/PTB7	I/O	117	PTE3	I/O			
14	D30/PTB6	I/O	Data bus / Port B	118	RAS3U/PTE2	I/O	RAS address bus / Port E	
15	D29/PTB5	I/O		119	PTE1	I/O	Port E	
16	D28/PTB4	I/O		120	TDO/PTE0	I/O	Test data / Port E	
17	D27/PTB3	I/O		121	BACK	O	Bus acknowledge	
18	D26/PTB2	I/O		122	BREQ	I	Bus request	
19	VssQ	-	Ground	123	WAIT	I	Hardware wait request	
20	D25/PTB1	I/O	Data bus / Port B	124	RESETM	I	Manual reset	
21	VccQ	-	Power supply +3.3 V	125	ADTRG/PTH5	I	Analog trigger / Port H	
22	D24/PTB0	I/O	Data bus / Port B	126	IOIS16/PTG7	I	Write protect / Port G	
23	D23/PTA7	I/O	Data bus / Port A	127	AEMD0/PTG6	I	ASE mode / Port G	
24	D22/PTA6	I/O		128	ASEBRKAK/PTG5	I/O	ASE break acknowledge / Port G	
25	D21/PTA5	I/O		129	PTG4/CKIO2	I/O	Port G / Clock output	
26	D20/PTA4	I/O		130	AUDATA3/PTG3	I/O	AUD data / Port G	
27	Vss	-		Ground	131	AUDATA2/PTG2		I/O
28	D19/PTA3	I/O	Data bus / Port A	132	Vss	-	Ground	
29	Vcc	-	Power supply +1.8 V	133	AUDATA1/PTG1	I/O	AUD data / Port G	
30	D18/PTA2	I/O	Data bus / Port A	134	Vcc	-	Power supply +1.8 V	
31	D17/PTA1	I/O		135	AUDATA0/PTG0	I/O	AUD data / Port G	
32	D16/PTA0	I/O		136	TRST1/PTF7/PINT15	I	Test reset / Port F / Port interruption	
33	VssQ	-		Ground	137	TMS/PTF6/PINT14	I	Test mode switch / Port F / Port interruption
34	D15	I/O		Data bus	138	TDI/PTF5/PINT13	I	Test data / Port F / Port interruption
35	VccQ	-	Power supply +3.3 V	139	TCK/PTF4/PINT12	I	Test clock / Port F / Port interruption	
36	D14	I/O	Data bus	140	IRLS0/PTF3/PINT11	I	Interrupt request / Port F / Port interruption	
37	D13	I/O		141	IRL2/PTF2/PINT10	I		
38	D12	I/O		142	IRLS1/PTF1/PINT9	I		
39	D11	I/O		143	IRLS0/PTF0/PINT8	I		
40	D10	I/O		144	MD0	I		Mode control
41	D9	I/O		145	Vcc(PLL1)	-		Power supply +1.8 V
42	D8	I/O		146	CAP1	-		Capacitor
43	D7	I/O		147	Vss(PLL1)	-		Ground
44	D6	I/O	148	Vss(PLL2)	-	Ground		
45	VssQ	-	Ground	149	CAP2	-	Capacitor	
46	D5	I/O	Data bus	150	VCC(PLL2)	-	Power supply +1.8 V	
47	VccQ	-	Power supply +3.3 V	151	AUDCK/PTH6	I	AUD clock / Port H	
48	D4	I/O	Data bus	152	Vss	-	Ground	
49	D3	I/O		153	Vss	-	Ground	
50	D2	I/O		154	Vcc	-	Power supply +1.8 V	
51	D1	I/O		155	XTAL1	O	Crystal oscillator	
52	D0	I/O		156	EXTAL1	O		
53	A0	O	Address bus	157	STATUS0/PTJ6	I/O	Processor status / Port J	
54	A1	O		158	STATUS1/PTJ7	I/O		
55	A2	O		159	TCLK/PTH7	I/O	Timer clock / Port H	
56	A3	O		160	/IRQOUT	O	Interrupt request output	
57	VssQ	-		Ground	161	VssQ	-	Ground
58	A4	O		Address bus	162	CKIO	I/O	System clock input / output
59	VccQ	-		Power supply +3.3 V	163	VccQ	-	Power supply +3.3 V
60	A5	O		Address bus	164	TXD0/SCPT0	O	Data transmission / SCI port
61	A6	O	165		SK0/SCPT1	I/O	Serial clock / SCI port	
62	A7	O	166		TXD1/SCPT2	O	Data transmission / SCI port	
63	A8	O	167		SK1/SCPT3	I/O	Serial clock / SCI port	
64	A9	O	168		TXD2/SCPT4	O	Data transmission / SCI port	
65	A10	O	169		SK2/SCPT5	I/O	Serial clock / SCI port	
66	A11	O	170		RTS2/SCPT6	I/O	Transmit request / SCI port	
67	A12	O	Data reception / SCI port		171	RXD0/SCPT0	I	
68	A13	O			172	RXD1/SCPT2	I	
69	VssQ	-	Ground		173	Vss	-	Ground
70	A14	O	Address bus	174	RXD2/SCPT4	I	Data reception / SCI port	
71	VccQ	-	Power supply +3.3 V	175	Vcc	-	Power supply +1.8 V	
72	A15	O	Address bus	176	CTS2/IRQ5/SCPT7	I	Transmit clear / Interrupt request / SCI port	
73	A16	O		177	MCS7/PTC7/PINT7	I/O	Mask ROM chip select / Port C / Port interruption	
74	A17	O		178	MCS6/PTC6/PINT6	I/O		
75	A18	O		179	MCS5/PTC5/PINT5	I/O		
76	A19	O		180	MCS4/PTC4/PINT4	I/O		
77	A20	O		Ground	181	VssQ	-	
78	A21	O			182	WAKEUP/PTD3	I/O	Standby mode Interrupt request output / Port D
79	Vss	-		Ground	183	VccQ	-	Power supply +3.3 V
80	A22	O		Address bus	184	RESETOUT/PTD2	I/O	Reset output / Port D
81	Vcc	-		Power supply +1.8 V	185	MCS3/PTC3/PINT3	I/O	Mask ROM chip select / Port C / Port interruption
82	A23	O	Address bus	186	MCS2/PTC2/PINT2	I/O		
83	VssQ	-	Ground	187	MCS1/PTC1/PINT1	I/O		
84	A24	O	Address bus	188	MCS0/PTC0/PINT0	I/O		
85	VccQ	-	Power supply +3.3 V	189	DRAK0/PTD1	I/O	DMA acknowledge / Port D	
86	A25	O	Address bus	190	DRAK1/PTD0	I/O		
87	BS/PTK4	I/O	Bus cycle / Port K	191	DREQ0/PTD4	I	DMA request / Port D	
88	RD	I/O	Read strobe	192	DREQ1/PTD6	I		
89	WE0/DQMLL	O	Select signal (D7-D0) / D QM (SDRAM)	193	RESETP	I	Power on reset	
90	WE1/DQMLU/WE	O	Select signal (D15-D8) / D QM (SDRAM) / Write enable	194	CA	I	Chip active	
91	WE2/DQMLUCOR/PTK6	I/O	Select signal (D23-D16) / D QM (SDRAM) / I/O read / Port K	195	MD3	I	Mode control	
92	WE3/DQMLUICOR/PTK7	I/O	Select signal (D31-D24) / D QM (SDRAM) / I/O write / Port K	196	MD4	I		
93	RD/WR	O	Read / Write	197	MD5	I		
94	AUDSYNC/PTE7	I/O	AUD cycle / Port E	198	AVss	-	Analog ground	
95	VssQ	-	Ground	199	ANO/PTL0	I	Analog input / Port L	
96	CS0/MCS0	O	Chip select / Mask ROM chip select	200	AN1/PTL1	I		
97	VccQ	-	Power supply +3.3V	201	AN2/PTL2	I		
98	CS2/PTK0	I/O	Chip select / Port K	202	AN3/PTL3	I		
99	CS3/PTK1	I/O		203	AN4/PTL4	I		
100	CS4/PTK2	I/O		204	AN5/PTL5	I		
101	CSS/CE1A/PTK3	O	Chip select / Chip enable / Port K	205	AVcc	-	Analog power supply +3.3 V	
102	CS6/CE1B	O	Chip select / Chip enable	206	AN6/DA1/PTL6	I/O	Analog input / Analog output / Port L	
103	CE2A/PTE4	I/O	Chip enable / Port E	207	AN7/DA0/PTL7	I/O		
104	CE2B/PTE5	I/O		208	AVss	-	Analog ground	

● YSS910-S (XV988A00) DSP6 (Digital Signal Processor)

PIN NO.	NAME	I/O	FUNCTION	PIN NO.	NAME	I/O	FUNCTION	
1	Vdd		Power supply (3.3 V)	89	Vss		Ground	
2	Vss		Ground	90	DB13	I/O	Parallel data bus	
3	XI	I	System master clock input (60 MHz or 30 MHz)	91	DB14	I/O		
4	XO	O	System master clock output (High or 30 MHz)	92	DB15	I/O		
5	Vdd5		Power supply (5 V)	93	DB16	I/O		
6	/SYNCl	I	Sync. signal input	94	DB17	I/O		
7	/SYNCO	O	Sync. signal output	95	DB18	I/O		
8	Vdd5		Power supply (5 V)	96	DB19	I/O		
9	CKI	I	System clock input (30 MHz)	97	DB20	I/O	Ground	
10	CKO	O	System clock output (30 MHz)	98	DB21	I/O		
11	CKSEL	I	System master clock select (0: 60 MHz, 1: 30 MHz)	99	DB22	I/O		
12	Vss		Ground	100	Vss		Ground	
13	MCKS	I	Serial I/O master clock input (128 x Fs)	101	Vdd		Power supply (3.3 V)	
14	/SSYNCl	I	Serial I/O Sync. signal input	102	DB23	I/O	Parallel data bus	
15	/IC	I	Initial clear (RESET)	103	DB24	I/O		
16	/TEST	I	Test mode setting (0: Test, 1: Normal)	104	DB25	I/O		
17	BTYP	I	Data bus type select (0: 8 bit, 1: 16 bit)	105	DB26	I/O		
18	/IRQ	O	IRQ output	106	DB27	I/O		
19	TRIG	I/O	Trigger signal input/output	107	DB28	I/O		
20	Vdd5		Power supply (5 V)	108	DB29	I/O		
21	Vss		Ground	109	DB30	I/O	Ground	
22	/CS	I	chip select signal input	110	DB31	I/O		
23	/WR	I	Write signal input	111	TIMO/DBOB	I/O	Timing signal output/ Parallel data bus output/ input	
24	/RD	I	Read signal input	112	Vss		Ground	
25	CA7	I/O	Address bus of internal register	113	Vdd5		Power supply (5 V)	
26	CA6	I/O						
27	CA5	I/O						
28	CA4	I/O						
29	CA3	I/O						
30	CA2	I/O	Memory data bus	114	DA00	I/O		
31	CA1	I/O						
32	Vss			Ground	115	DA01	I/O	
33	Vdd			Power supply (3.3 V)	116	DA02	I/O	
34	CD15	I/O		Data bus of internal register	117	DA03	I/O	
35	CD14	I/O						
36	CD13	I/O						
37	CD12	I/O						
38	CD11	I/O						
39	CD10	I/O						
40	CD09	I/O						
41	CD08	I/O	Memory data bus	118	DA04	I/O		
42	CD07	I/O						
43	CD06	I/O						
44	Vss			Ground	119	DA05	I/O	
45	Vdd			Power supply (3.3 V)	120	DA06	I/O	
46	Vdd5			Power supply (5 V)	121	DA07	I/O	
47	CD05	I/O		Data bus of internal register	122	Vss		Ground
48	CD04	I/O						
49	CD03	I/O						
50	CD02	I/O						
51	CD01	I/O						
52	CD00	I/O						
53	/WAIT	O	WAIT output		123	DA08	I/O	
54	Vss		Ground	124	DA09	I/O		
55	SI0	I	Serial data input	125	DA10	I/O	Memory data bus	
56	SI1	I						
57	SI2	I						
58	SI3	I						
59	SI4	I						
60	SI5	I						
61	SI6	I						
62	SI7	I						
63	Vss		Ground	126	DA11	I/O		
64	Vdd5		Power supply (5 V)	127	DA12	I/O		
65	SO0	O	Serial data output	128	DA13	I/O	Memory data bus	
66	SO1	O						
67	SO2	O						
68	SO3	O						
69	SO4	O						
70	SO5	O						
71	SO6	O						
72	SO7	O						
73	Vss		Ground	129	DA14	I/O		
74	DB00	I/O	Parallel data bus	130	DA15	I/O		
75	DB01	I/O						
76	DB02	I/O						
77	DB03	I/O						
78	DB04	I/O						
79	DB05	I/O						
80	DB06	I/O						
81	DB07	I/O	Memory address (SRAM, PSRAM, DRAM)	131	Vss		Ground	
82	DB08	I/O						
83	DB09	I/O						
84	DB10	I/O						
85	DB11	I/O						
86	DB12	I/O						
87	Vdd5			Power supply (5 V)	132	Vdd		Power supply (3.3 V)
88	Vdd		Power supply (3.3 V)	133	(n.c)		Not used	
				134	Vdd5		Power supply (5 V)	
				135	DA16	I/O	Memory data bus	
				136	DA17	I/O		
				137	DA18	I/O		
				138	DA19	I/O		
				139	DA20	I/O		
				140	DA21	I/O		
				141	DA22	I/O		
				142	DA23	I/O		
				143	Vss		Ground	
				144	DA24	I/O	Memory data bus	
				145	DA25	I/O		
				146	DA26	I/O		
				147	DA27	I/O		
				148	DA28	I/O		
				149	DA29	I/O		
				150	DA30	I/O		
				151	DA31	I/O		
				152	Vdd5		Power supply (5 V)	
				153	Vss		Ground	
				154	A00	O	Memory address (SRAM, PSRAM, DRAM)	
				155	A01	O		
				156	A02	O		
				157	A03	O		
				158	A04	O		
				159	A05	O		
				160	A06	O		
				161	A07	O		
				162	A08	O	Memory address (SRAM, PSRAM, DRAM)	
				163	A09	O		
				164	Vss			Ground
				165	Vdd			Power supply (3.3 V)
				166	A10	O		
				167	A11	O		
				168	A12	O		
				169	A13	O		
				170	A14	O	Memory address (SRAM, PSRAM), /RAS (DRAM)	
				171	A15/RAS	O		
				172	A16/CAS	O		
				173	A17/CE	O		
				174	/WE	O		
				175	/OE	O		
				176	Vdd5			Power supply (5 V)

● CS8415A-CS (X2089A00) DIR (Digital Audio Interface Receiver)

MAIN: IC401

PIN NO.	NAME	I/O	FUNCTION	PIN NO.	NAME	I/O	FUNCTION
1	CDOUT	O	Data out (SPI)	15	RXP4	I	Additional AES3/SPDIF receiver port
2	/CS	I	Control port chip select (SPI)	16	OSCLK	I/O	Serial audio output bit clock
3	/EMPH	O	Pre-emphasis	17	OLRCK	I/O	Serial audio output left/right clock
4	RXP0	I	} AES3/SPDIF receiver port	18	SDOUT	O	Serial audio output data
5	RXN0	I		19	INT	O	Interrupt
6	VA+	I		20	U	O	User data
7	AGND	I	Positive analog power supply +5V	21	OMCK	I	System clock
8	FILT	O	Analog ground	22	DGND	I	Digital ground
9	/RST	O	PLL loop filter	23	VL+	I	Positive logic power supply +5V
10	RMCK	I/O	Reset	24	H/S	I	Hardware/software mode control
11	RERR	O	Input section recovered master clock	25	RXP5	I	} Additional AES3/SPDIF receiver port
12	RXP1	I	Receiver error	26	RXP6	I	
13	RXP2	I	} Additional AES3/SPDIF receiver port	27	CDIN	I	
14	RXP3	I		28	CCLK	I	Control port clock

● YM3436DK (XG948E00) DIR2 (Digital Format Interface Receiver)

MAIN: IC205

PIN NO.	NAME	I/O	FUNCTION	PIN NO.	NAME	I/O	FUNCTION
1	DAUX	I	Auxiliary input for audio data	23	RSTN	I	System reset input
2	HDLT	O	Asynchronous buffer operation flag	24	Vdda	I	VCO section power (+5V)
3	DOUT	O	Audio data output	25	CTLN	I	VCO control input N
4	VFL	O	Parity flag output	26	PCO	O	PLL phase comparison output
5	OPT	O	Fs x 1 Synchronous output signal for DAC	27	(NC)	I	
6	SYNC	O	Fs x 1 Synchronous output signal for DSP	28	CTLP	I	VCO control input P
7	MCC	O	Fs x 64 Bit clock output	29	Vssa	I	VCO section power (GND)
8	WC	O	Fs x 1 Word clock output	30	TSTN	I	Test terminal. Open for normal use
9	MCB	O	Fs x 128 Bit clock output	31	KM2	I	Clock mode switching input 2
10	MCA	O	Fs x 256 Bit clock output	32	KM0	I	Clock mode switching input 0
11	SKSY	I	Clock synchronization control input	33	FS1	O	Channel status sampling frequency display output 1
12	XI	I	Crystal oscillator connection or external clock input	34	FS0	O	Channel status sampling frequency display output 0
13	XO	O	Crystal oscillator connection	35	CSM	I	Channel status output method selection
14	P256	O	VCO oscillating clock connection	36	EXTW	I	External synchronous auxiliary input word clock
15	LOCK	O	PLL lock flag	37	DDIN	I	EIAJ (AES/EBU) data input
16	Vss	I	Logic section power (GND)	38	LR	O	PLL word clock output
17	TC	O	PLL time constant switching output	39	Vdd	I	Logic section power (+5 V)
18	DIM1	I	Data input mode selection	40	ERR	O	Data error flag output
19	DIM0	I	Data input mode selection	41	EMP	O	Channel status emphasis control code output
20	DOM1	I	Data output mode selection	42	CD0	O	3-wire type microcomputer interface data output
21	DOM0	I	Data output mode selection	43	CCK	I	3-wire type microcomputer interface clock input
22	KM1	I	Clock mode switching input 1	44	CLD	I	3-wire type microcomputer interface load input

● CS8405A-CS (XZ349A00) DIT (Digital Audio Interface Transmitter)

MAIN: IC405

PIN NO.	NAME	I/O	FUNCTION	PIN NO.	NAME	I/O	FUNCTION
1	SDA/CDOUT	I/O	Serial control data I/O (I ² C) / Data out (SPI)	15	TCBL	I/O	Transmit channel status block start
2	AD0//CS	I/O	Address bit 0 (I ² C) / Control port chip select (SPI)	16	NC3	I	} Not used
3	AD2	I	Address bit 2 (I ² C)	17	NC4	I	
4	RXP	I	Auxiliary AES3 Receiver port	18	NC5	I	
5	DGND2	I	Digital ground	19	INT	O	Interrupt
6	VD2+	I	Positive digital power supply (+5V)	20	U	I/O	User data
7	DGND4	I	} Digital ground	21	OMCK	I	Master clock
8	DGND3	I		22	DGND	I	Digital ground
9	/RST	I		Reset	23	VD+	I
10	NC1	I	} Not used	24	H/S	I	Hardware/software control mode select
11	NC2	I		25	TXN	O	} Differential line drivers
12	ILRCK	I/O	Serial audio input left/right clock	26	TXP	O	
13	ISCLK	I/O	Serial audio bit clock	27	AD1/CDIN	I	
14	SDIN	I	Serial audio data port	28	SCL/CCLK	I	Control port clock

● **CS5361-KS (X3447A00) ADC (Analog to Digital Converter)**

MAIN: IC603

PIN NO.	NAME	I/O	FUNCTION	PIN NO.	NAME	I/O	FUNCTION
1	/RST	I	Reset	13	M0	I	} Mode selection
2	M/S	I	Master/slave mode	14	M1	I	
3	LRCK	I/O	Left right clock	15	TST	I	Test
4	SCLK	I/O	Serial clock	16	AINL+	I	} Differential left channel analog input
5	MCLK	I	Master clock	17	AINL-	I	
6	VD		Digital power supply +5V	18	GND		Ground
7	GND		Ground	19	VA		Analog power supply +5V
8	VL		Logic power supply +3.3V	20	AINR-	I	} Differential right channel analog input
9	SDOUT	O	Serial audio data output	21	AINR+	I	
10	DIV	I	Divider	22	VCOM	O	Common voltage
11	/HPF	I	High pass filter enable	23	REFGND	O	Reference ground
12	DIF	I	Digital input format	24	FILT+	O	Positive voltage reference

● **AK4393-VF-E2 (XW029A00) DAC (Digital to Analog Converter)**

MAIN: IC701

PIN NO.	NAME	I/O	FUNCTION	PIN NO.	NAME	I/O	FUNCTION
1	DVSS	-	Digital ground	15	BVSS	-	Substrate ground
2	DVDD	-	Digital power supply	16	VREFL	I	Low level voltage reference
3	MCLK	I	Master clock	17	VREFH	I	High level voltage reference
4	/PD	I	Power down mode	18	AVDD	-	Analog power supply +5 V
5	BICK	I	Audio serial data clock	19	AVSS	-	Analog ground
6	SDATA	I	Audio serial data input	20	AOUTR-	O	Rch negative analog output
7	LRCK	I	L/R clock	21	AOUTR+	O	Rch positive analog output
8	SMUTE/CS	I	Soft mute	22	AOURL-	O	Lch negative analog output
9	DFS	I	Double speed sampling mode	23	AOURL+	O	Lch positive analog output
10	DEMO/CCLK	I	} De-emphasis enable	24	VCOM	O	Common voltage output
11	DEM1/CDTI	I					
12	DIF0	I	} Digital input format	25	P/S	I	Parallel/serial select
13	DIF1	I					
14	DIF2	I					
				26	CKS0	I	} Master clock select
				27	CKS1	I	
				28	CKS2	I	

■ **IC BLOCK DIAGRAM (IC ブロック図)**

● **TC74VHC00FT (X2313A00)**

Quad 2 Input NAND

MAIN: IC209

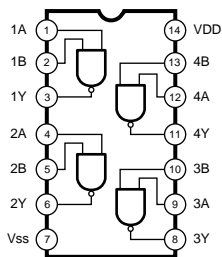

● **TC74VHC04FT (X0195A00)**

Hex Inverter

MAIN: IC207, 501

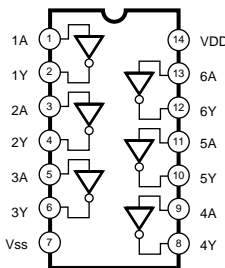

● **TC74VHCT08AFT (X3586A00)**

TC74VHC08FT (XV891A00)

Quad 2 Input AND

MAIN: IC404

IC005, 107

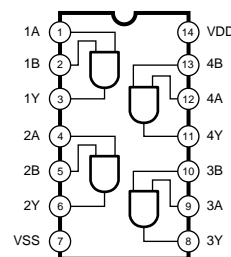

- **TC74VHC14FT** (XV890A00)
Hex Inverter
MAIN: IC208

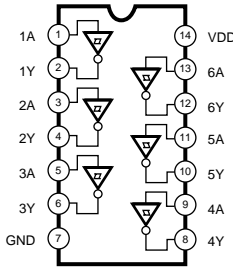

- **TC74VHC32FT** (XY945A00)
Quad 2 Input OR
MAIN: IC012

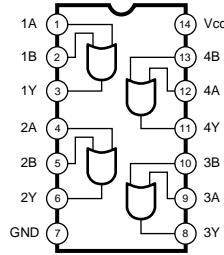

- **TC74VHC74FT** (XV892A00)
Dual D-Type Flip-Flop
MAIN: IC206

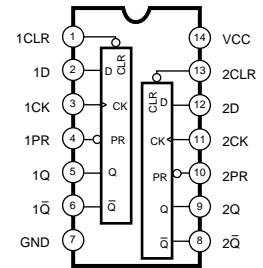

INPUTS				OUTPUTS	
PR	CLR	CLK	D	Q	Q̄
L	H	X	X	H	L
H	L	X	X	L	H
L	L	X	X	H	H
H	H	f	H	H	L
H	H	f	L	L	H
H	H	L	X	Q _o	Q _o

- **TC74VHC244FT** (XW234A00)
Octal 3-State Bus Buffer
MAIN: IC403

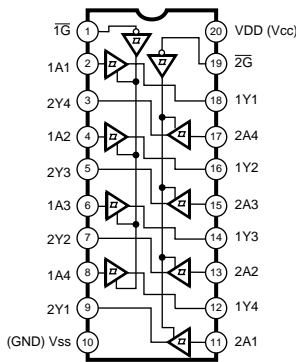

- **TC74VHCT245AFT** (XT744A00)
Octal 3-State Bus Transceiver
MAIN: IC-103-106, 203, 606

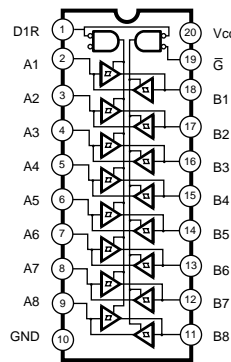

- **74LVX4245MTCX** (X3097A00)
Dual Supply Octal Bus Transceiver
MAIN: IC-101, 102

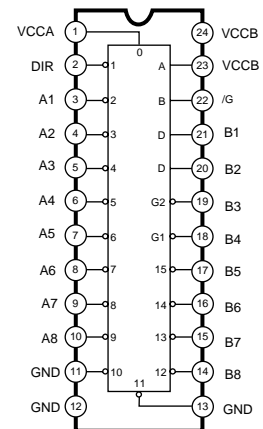

- **SN75124NSR** (XV930A00)
Triple Line Receiver
MAIN: IC406

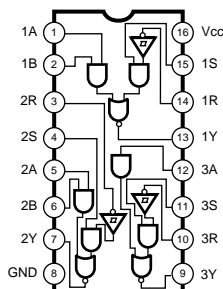

- **TC7SH04FU** (XS775A00)
Inverter Gate
MAIN: IC003, 210, 402, 605

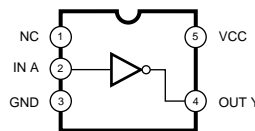

- **μPC4570G2** (XF291A00)
Dual Operational Amplifier
MAIN: IC601, 602, 651, 652, 703, 753

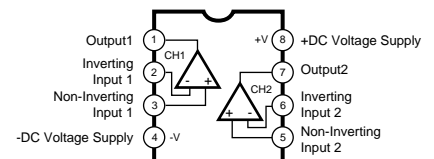

- **NJM2904V(TE1)** (XR532A00)
Dual Operational Amplifier
MAIN: IC002

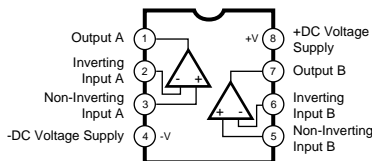

- **NJM4556AL** (XP844A00)
Dual Operational Amplifier
MAIN: IC704, 754

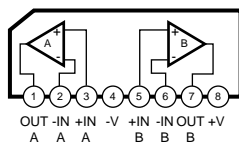

- **TLC2932IPWR** (XV064A00)
PLL
MAIN: IC204

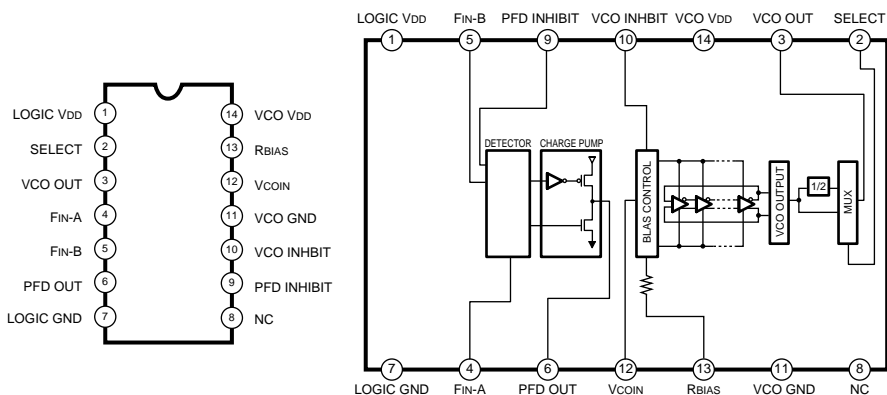

■ CIRCUIT BOARDS CONTENTS(シート基板図目次)

FOOTSW (X4199B0)	28	PN2 (X4199B0)	23
JKIN (X4199B0)	28	PN3 (X4199B0)	23
JKOUT (X4199B0)	28	POWER (X4199B0)	28
MAIN (X498B0)	24/26	VOL (X4199B0)	28
PN1 (X4199B0)	23		

Note : See parts list for details of circuit board component parts.

注: シートの部品詳細は、パーツリストをご参照ください。

■ CIRCUIT BOARDS (シート基板図)

● PN3 Circuit Board

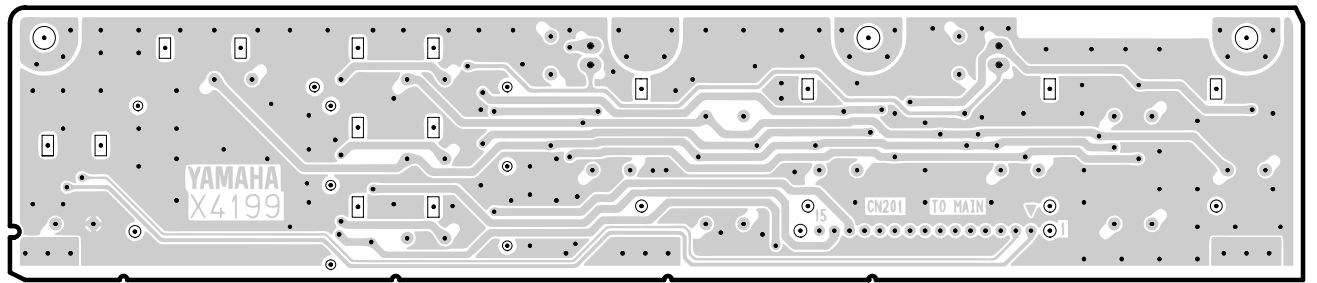
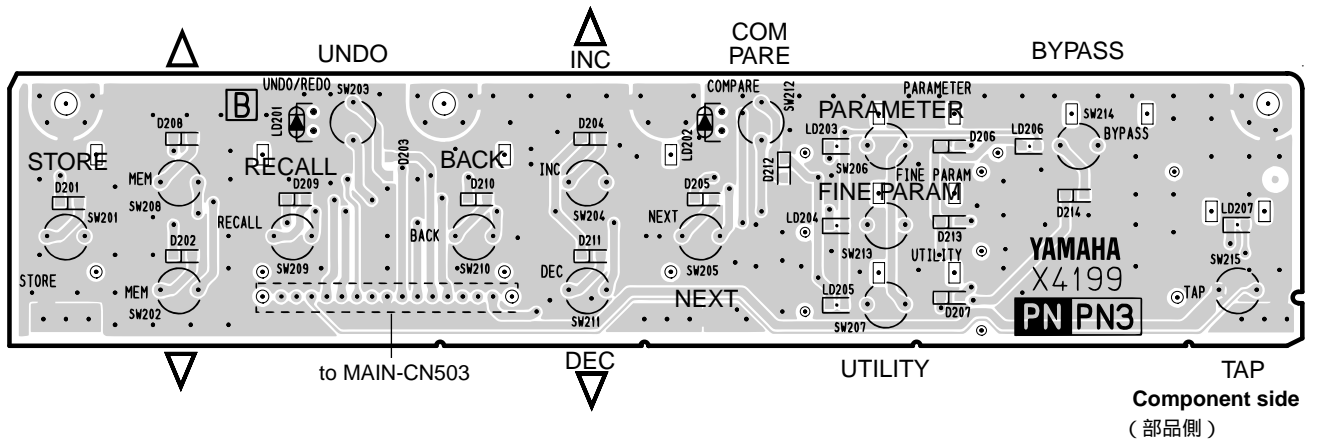

● PN1 Circuit Board

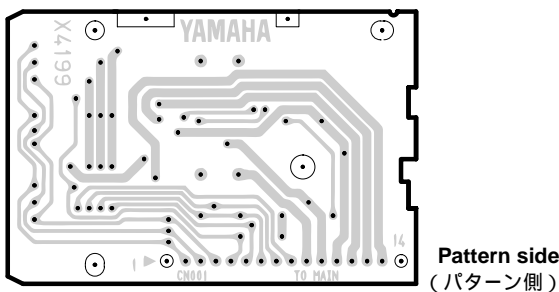
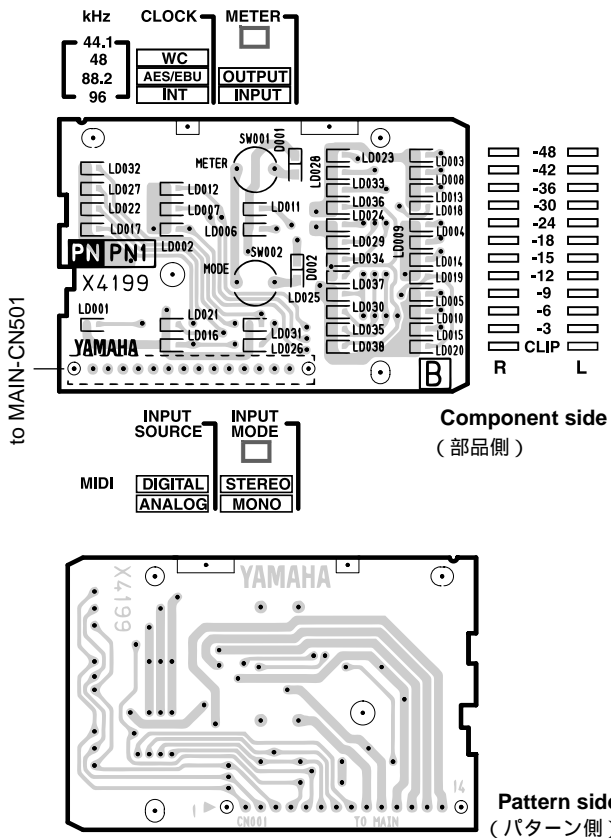

● PN2 Circuit Board

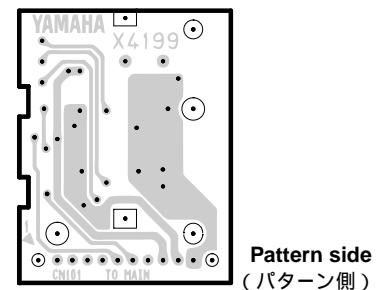
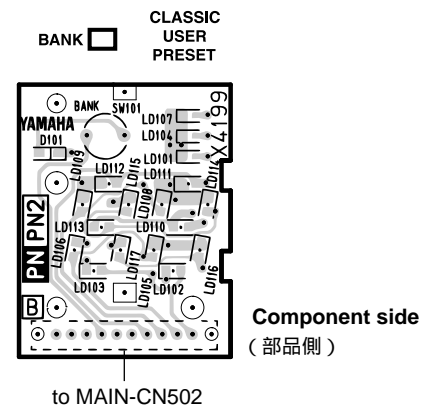

● MAIN Circuit Board

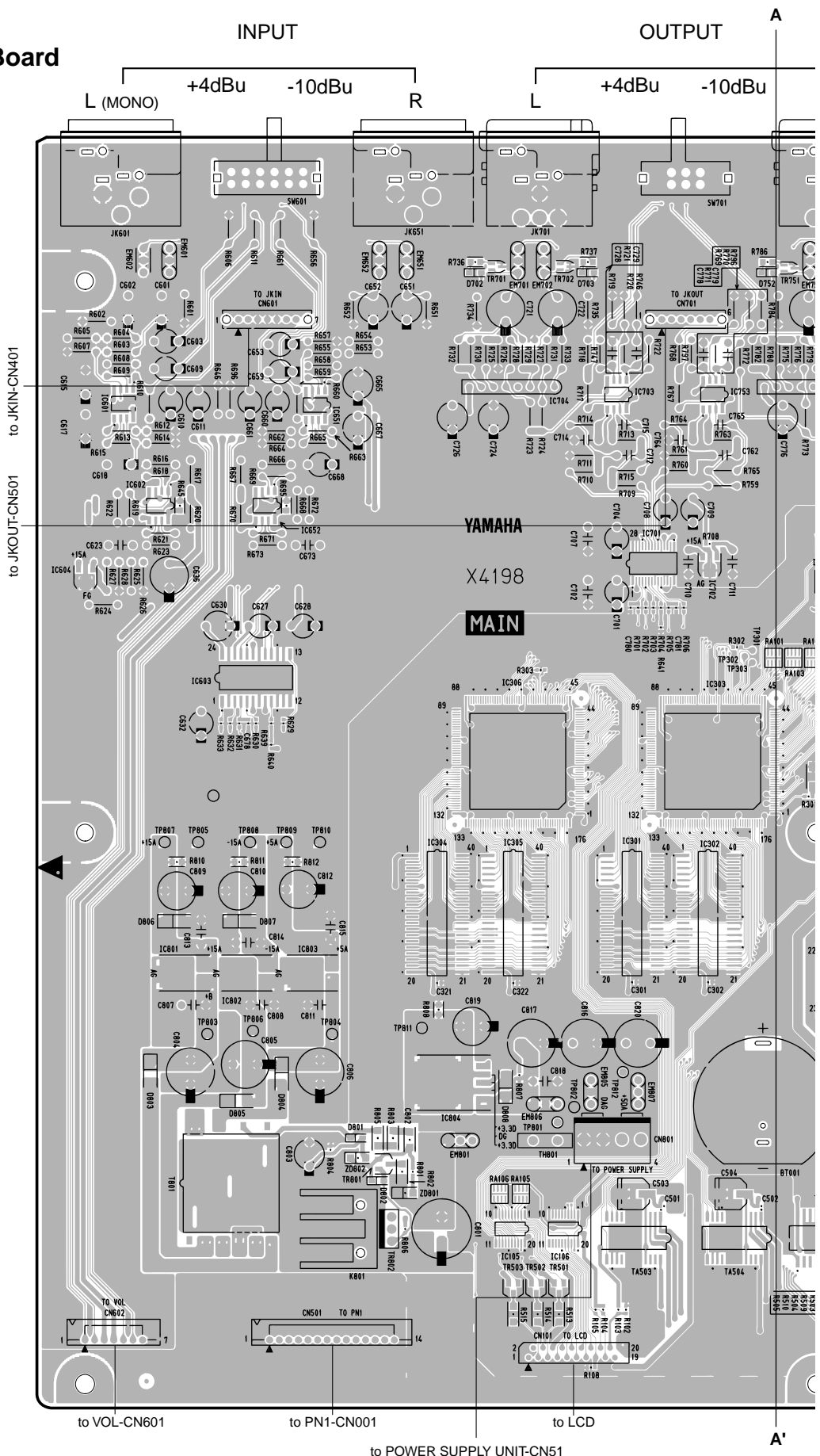

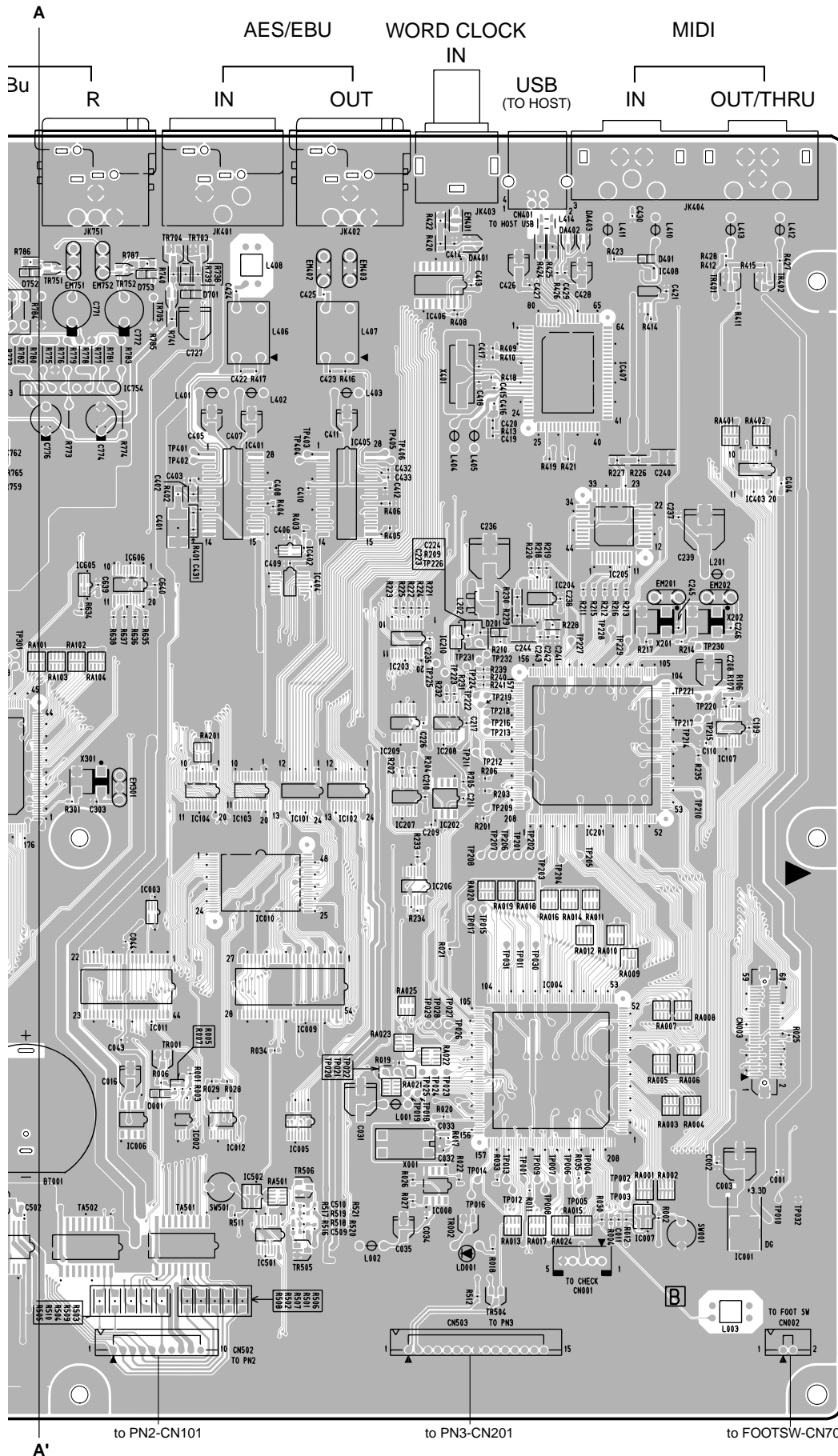

Component side (部品側)

● MAIN Circuit Board

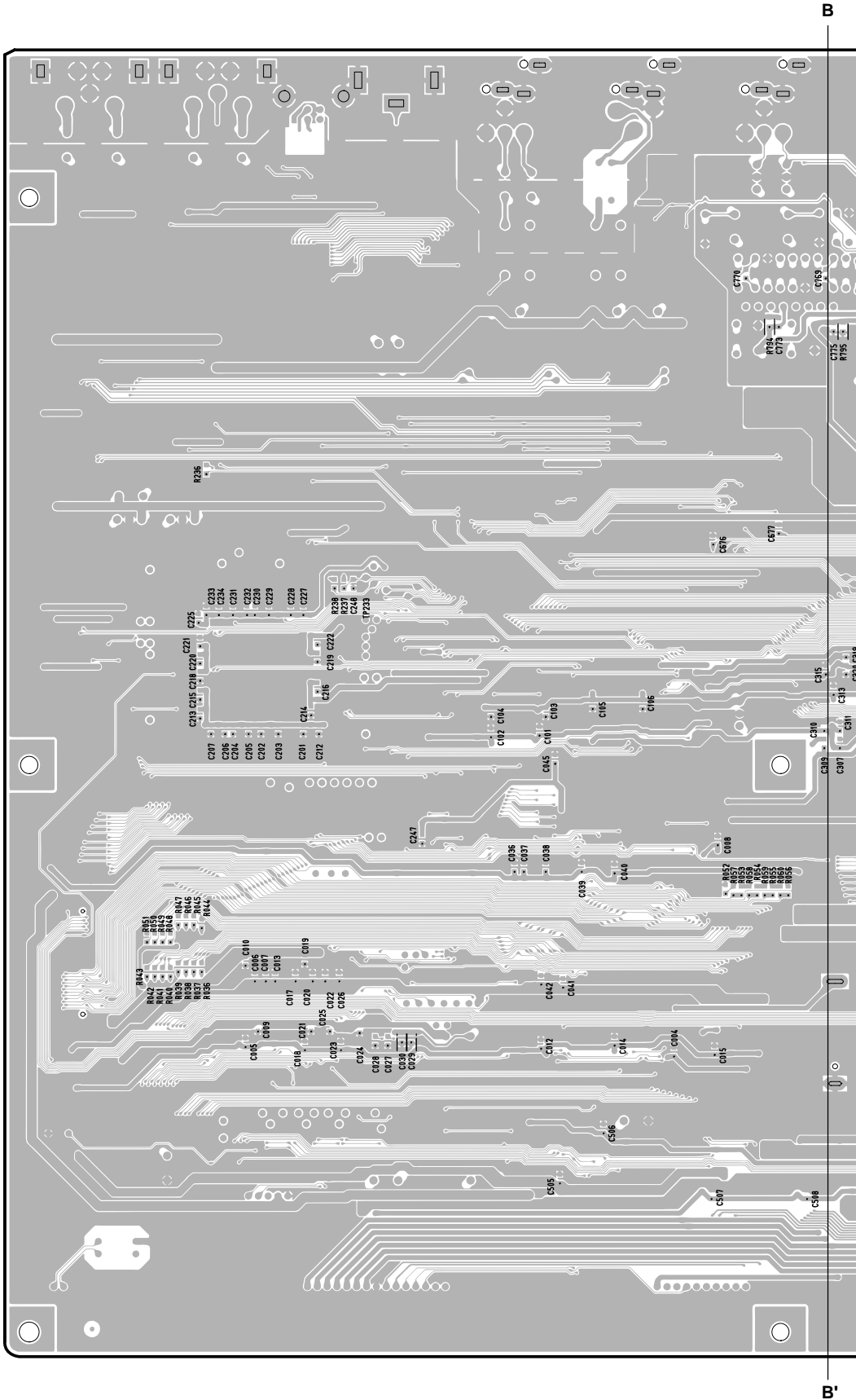

● JKIN Circuit Board

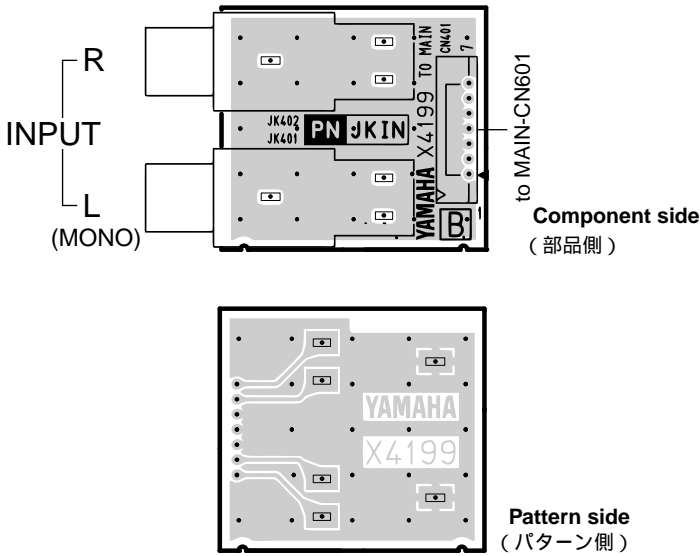

● FOOTSW Circuit Board

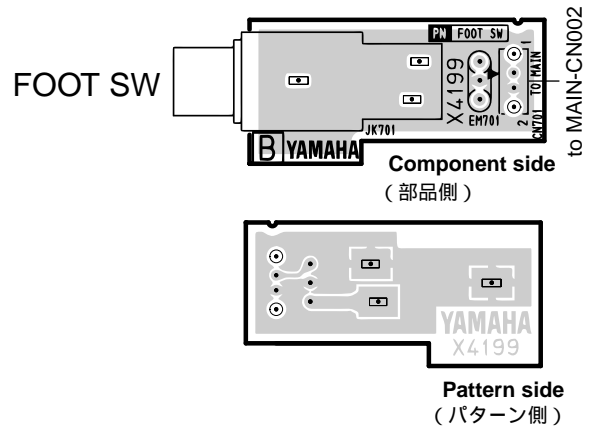

● VOL Circuit Board

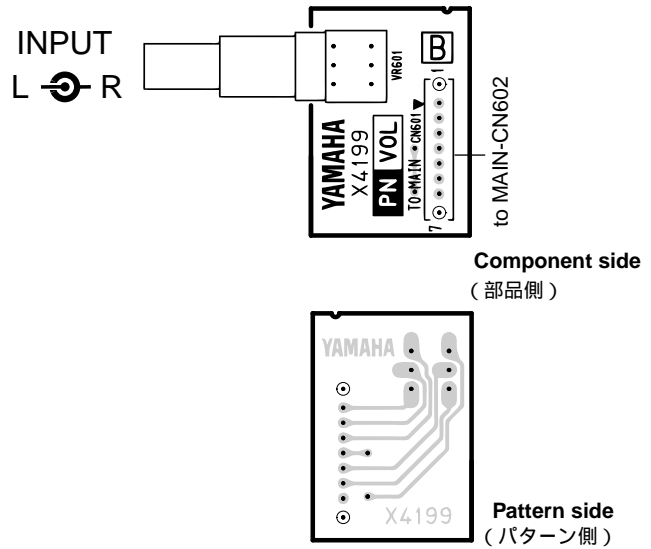

● JKOUT Circuit Board

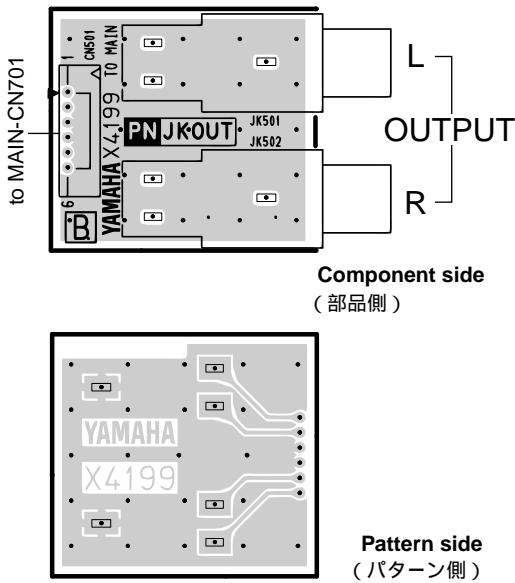

● POWER Circuit Board

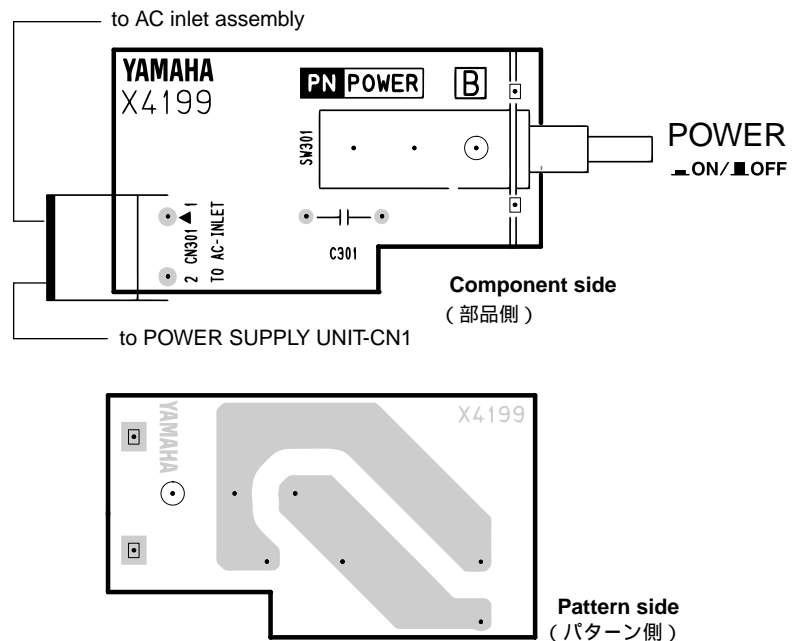

INSPECTIONS

1. Preparations

1-1. Conditions

Use following conditions unless otherwise specified.

- INPUT VOLUME: MAX
- Level select switch: +4dBu side (both input and output)
- Analog output load: 600 Ω
- Word clock (FS): 96kHz

To select the word clock, press the UTILITY key several times and when "CLOCK SOURCE" appears on the LCD, press the INC/DEC key.

- 0dBu = 0.775Vrms
- 0dBFS = 0dB, full scale
- Oscillator output impedance: 150 Ω.
A sine wave is output.
- Input impedance of oscilloscope, level meter, etc.: 100 kΩ or more
- Noise measurement is corrected with 12.7kHz, -6dB/octave low pass filter. (Use average values instead of effective values for measurement.)
- Cross talk and distortion ratio measurement is corrected with 80kHz, -18dB/octave low pass filter.
- For check items other than "2-7", turn on the BYPASS key and keep the BYPASS LED lit while checking.

1-2. Measuring Instruments

- Use System Two CASCADE Control Software APWIN Version 2.22 of Audio Precision Co. or its equivalent.
- Noise meter (Use LMV-1817 of READER Corp. or the equivalent when measuring the noise.)

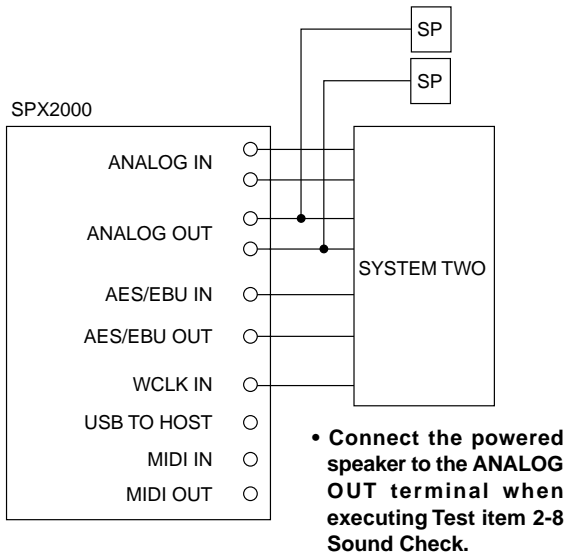

1-3. Writing Programs

If the main program is not the latest version, it must be upgraded to the latest program. For the details, refer to "Method for Writing the Program" on page 49.

2. Check Items

2-1. When ANALOG INPUT/OUTPUT WORD CLOCK is INT 96kHz

Condition:

Signals are inputted through ANALOG INPUT L, R (XLR) and output from ANALOG OUTPUT L, R (XLR).

[1] Gain (both L and R)

Connecting hot and cold terminals of OUTPUT L, R to GND respectively provides the same result.

Input frequency	Input level	Specified output level	Permissible range
1 kHz	+4 dBu	+14 dBu	+14 ± 2 dBu

[2] Frequency response (both L and R)

Condition:

1kHz is used as reference of the permissible range.

Input frequency	Input level	Permissible range
20 Hz	+4 dBu	-1.5 ~ +0.5 dB
40 kHz	+4 dBu	-1.5 ~ +0.5 dB

[3] Level difference between left and right

The range of difference in the gain measured in [1] above is specified as follows.

Permissible range
Within 1dB

[4] Residual noise (both L and R)

Condition: The input function should be turned off.

Permissible range
-80 dBu or below

[5] Crosstalk between left and right

Condition:

The R channel input function should be turned off when signals are inputted to the L channel.

The L channel input function should be turned off when signals are inputted to the R channel.

Input frequency	Output level L(R)	Permissible range R (L)
1 kHz	+22 dBu	-58 dBu or below

2-2. When ANALOG INPUT/OUTPUT WORD CLOCK is INT 48kHz

Condition:

Signals are inputted through ANALOG INPUT L, R (PHONE) and output from ANALOG OUTPUT L, R (PHONE).

[1] Distortion ratio (both L and R)

Input frequency	Output level	Permissible range
1 kHz	+23 dBu	0.02 % or below

[2] Residual noise (both L and R)

Condition: The input function should be turned off.

Permissible range
-80 dBu or below

2-3. Checking ANALOG INPUT/OUTPUT Level Select Switch

Condition:

Signals are inputted through ANALOG INPUT L, R (PHONE) and output from ANALOG OUTPUT L, R (PHONE).

The level select switch should be set to -10dBu side (both input and output) and WORD CLOCK INT should be set to 48kHz.

[1] Gain (both L and R)

Input frequency	Input level	Specified output level	Permissible range
1 kHz	-10 dBu	0 dBu	0 ± 2 dBu

2-4. Checking DIGITAL OUT

Condition: Use the System Two.

Signals are inputted through ANALOG INPUT L, R (XLR) and output from AES/EBU OUT.

a. WORD CLOCK INT 96kHz

Condition: Set WORD CLOCK INT to 96kHz.

[1] Gain (AES/EBU OUT)

Input frequency	Input level	Specified output level	Permissible range
1 kHz	+4 dBu	-10 dBFS	-10 ± 2 dBFS

[2] Frequency response (AES/EBU OUT)

Condition:

1kHz is used as reference of the permissible range.

Input frequency	Input level	Permissible range
20 Hz	+4 dBu	-1.0 ~ +0.5 dB
40 kHz	+4 dBu	-1.0 ~ +0.5 dB

[3] Distortion ratio (AES/EBU OUT)

Input frequency	Output level	Permissible range
1 kHz	-1 dBFS	0.01 % or below

b. WORD CLOCK INT 48kHz

Condition: Set WORD CLOCK INT to 48kHz.

[1] Distortion ratio (AES/EBU OUT)

Input frequency	Output level	Permissible range
1 kHz	-1 dBFS	0.02 % or below

2-5. Checking DIGITAL IN

Condition: Use the System Two.

Signals are inputted through AES/EBU IN and output from ANALOG OUT L, R (XLR).

Select AES/EBU for the word clock.

Setting: Input selection

Press the UTILITY key and when "INPUT SOURCE" appears on the LCD, press the INC key.

Setting is completed when the asterisk (*) mark moves to the "DIGITAL" position.

Press the BACK key and execute WORD CLOCK selection.

a. 96kHz

Condition: Make frequency setting (Sample Rate) of the System Two to 96kHz.

[1] Gain (both L and R)

Input frequency	Input level	Specified output level	Permissible range
1 kHz	-10 dBFS	+14 dBu	+14 ± 2 dBu

[2] Frequency response (both L and R)

Condition:

1kHz is used as reference of the permissible range.

Input frequency	Input level	Permissible range
20 Hz	-10 dBFS	-1.0 ~ +0.5 dB
40 kHz	-10 dBFS	-1.0 ~ +0.5 dB

[3] Distortion ratio (both L and R)

Input frequency	Output level	Permissible range
1 kHz	+22 dBu	0.01 % or below

b. 48kHz

Condition: Make frequency setting (Sample Rate) of the System Two to 48kHz.

[1] Distortion ratio (both L and R)

Input frequency	Output level	Permissible range
1 kHz	+23 dBu	0.02 % or below

Supplementary)

After this test, press the UTILITY key again and when "INPUT SOURCE" appears on the LCD, press the DEC key. Setting is completed when the asterisk (*) mark moves to the "ANALOG" position. Press the BACK key and execute WORD CLOCK selection.

2-6. PLL Operation Range of WORD CLOCK IN, DIGITAL IN

Condition: Use the System Two.

Signals are inputted through ANALOG INUT L, R (XLR) and output from OUTPUT L, R (XLR).

The WORD CLOCK should be selected as follows.

When checking WORD CLOCK IN: WORD CLOCK

When checking DIGITAL IN: AES/EBU

a. 96kHz + 6% (101.76kHz)

Condition:

Make frequency setting (Sample Rate) of the System Two to 96kHz + 6%

[1] Distortion ratio (both WORD CLOCK IN and DIGITAL IN)

Input frequency	Output level	Permissible range
1 kHz	+23 dBu	0.03 % or below

b. 44.1kHz - 10% (39.69kHz)

Condition:

Make frequency setting (Sample Rate) of the System Two to 44.1kHz - 10%

[1] Distortion ratio (both WORD CLOCK IN and DIGITAL IN)

Input frequency	Output level	Permissible range
1 kHz	+23 dBu	0.03 % or below

2-7. Jitter Measurement

Condition: User the System Two.

Select Sec and PK.

Select BW: 700Hz to 100kHz.

Use AES/EBU OUT for checking.

a. WORD CLOCK INT

Condition:

Select the value of the WORD CLOCK according to the following table.

[1] Jitter

WORD CLOCK	Permissible range
INT 44 .1 kHz	2 nsec or below
INT 48 kHz	2 nsec or below
INT 88 .2 kHz	2 nsec or below
INT 96 kHz	2 nsec or below

b. WORD CLOCK EXT

Condition: Select the WORD CLOCK as follows.

When checking WORD CLOCK IN: WORD CLOCK

When checking DIGITAL IN: AES/EBU

For the System Two frequency setting (Sample Rate), select the value for according to the table below.

[1] Jitter (both WORD CLOCK IN and DIGITAL IN)

WORD CLOCK	Permissible range
EXT 44 .1 kHz	4 nsec or below
EXT 48 kHz	4 nsec or below
EXT 88 .2 kHz	4 nsec or below
EXT 96 kHz	4 nsec or below

2-8. Checking Produced Sound

Check EFFECT functions (DSP6 operation check) by listening. ANALOG INPUT, ANALOG OUTPUT

Condition

- WORD CLOCK: INT96kHz
- Input sound signals through ANALOG INPUT L and R (XLR), recall the PRESET programs listed below one after another and adjust the INPUT VOLUME so that the CLIP of the LEVEL METER does not light up with any program.

To recall the PRESET programs, press the UP/DOWN key to have a number flash in the 7-segment and press the RECALL key.

PRESET programs to be checked

Program 08: AMBIENCE

Program 58: ROGER ON THE 12

Program 61: SYMPHONIC

Program 78: DYNA FILTER

Inspection:

Recall the PRESET programs and check the signal through the speaker for at least 15 seconds. Perform this check on all 4 types of the PRESET programs. Operate the INPUT VOLUME and check that the output level varies.

Judgment criteria 1: The EFFECT sounds are output.

Judgment criteria 2: No noise is included in the output.

検査

1 準備

1 - 1 条件

特に指定しないときは以下の条件とします。

- ・ INPUT VOLUME: MAX
- ・ レベル切替SW: + 4dBu側(入力、出力共)
- ・ アナログ出力の負荷は、600 Ωとします。
- ・ ワードクロック(FS)は96kHzにします。
なお、ワードクロックの切り替えをするには、UTILITYキーを何度か押しLCDに CLOCK SOURCEが表示されたところで、INC/DECキーを押します。
- ・ 0dBu = 0.775Vrms
- ・ 0dBFS = 0デシベル・フルスケール
- ・ 発振器の出力インピーダンスは150 Ωとします。
正弦波を出力します。
- ・ オシロスコープ、レベル計等の入力インピーダンスは100k Ω以上とします。
- ・ ノイズ測定は12.7kHz、- 6dB / OCTのLPFで補正します。(実効値ではなく平均値での測定とします。)
- ・ クロストークと歪率の測定は80kHz、- 18dB / OCTのLPFで補正します。
- ・ 検査項目2 - 7以外はBYPASSキーをオンにして、BYPASSのLEDを点灯させた状態で検査します。

1 - 2 測定器

- ・ Audio Precision社System Two CASCADE制御ソフトウェアAPWIN Version 2.22と同等品を使用します。
- ・ ノイズメーター(READER社 LMV-1817または同等品をノイズ測定時に使用します)

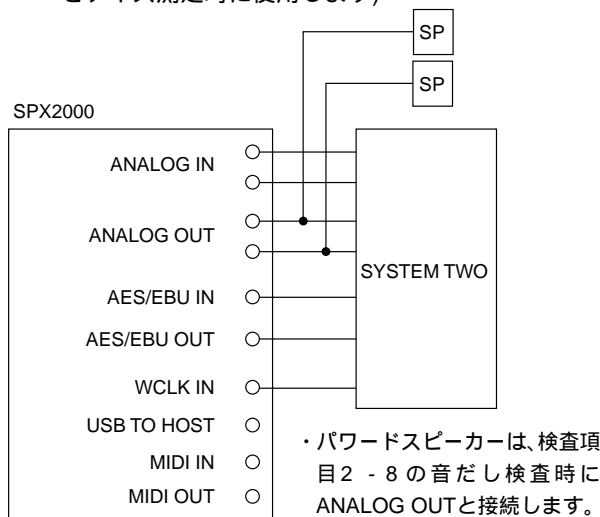

1 - 3 プログラムの書き込み

本体プログラムが、最新バージョンになっていない場合、最新のプログラムにバージョンアップする必要があります。詳しくは、49ページの「プログラムの書き込み」を参照してください。

2 検査項目

2 - 1 .ANALOG INPUT/OUTPUTのWORD CLOCK

INT96kHz時検査

条件 ANALOG INPUT L,R(XLR)から入力し、ANALOG OUTPUT L,R(XLR)から出力します。

① 利得 (L/R共)

OUTPUT L,Rのホット、コールド端子をそれぞれGNDに接続しても同様の結果が得られます。

入力周波数	入力レベル	規定出力レベル	許容範囲
1kHz	+ 4dBu	+ 14dBu	+ 14 ± 2dBu

② f 特 (L/R共)

条件 許容範囲は1kHzを基準とします。

入力周波数	入力レベル	許容範囲
20Hz	+ 4dBu	- 1.5 ~ + 0.5dB
40kHz	+ 4dBu	- 1.5 ~ + 0.5dB

③ L/R 間のレベル差

①で測定した利得の差の範囲を以下の様に規定します。

許容範囲
1dB以内

④ 残留ノイズ (L/R共)

条件 入力をOFFにします。

許容範囲
- 80dBu以下

⑤ L/R 間のクロストーク

条件 Lchに信号を入力した時は、Rchの入力をOFFにします。

Rchに信号を入力した時は、Lchの入力をOFFにします。

入力周波数	出力レベルL(R)	許容範囲R(L)
1kHz	+ 22dBu	- 58dBu以下

2 - 2 .ANALOG INPUT/OUTPUTのWORD CLOCK INT48kHz時検査

条件 ANALOG INPUT L,R(PHONE)から入力し、ANALOG OUTPUT L,R(PHONE)から出力します。

① 歪率 (L / R 共)

入力周波数	出力レベル	許容範囲
1kHz	+ 23dBu	0.02%以下

② 残留ノイズ (L / R 共)

条件 入力をOFFにします。

許容範囲
- 80dBu以下

2 - 3 .ANALOG INPUT/OUTPUTのレベル切替SWの検査

条件 ANALOG INPUT L,R(PHONE)から入力し、ANALOG OUTPUT L,R(PHONE)から出力します。
レベル切替SWは - 10dBu側(入出力共)、WORD CLOCK INTは48kHzです。

① 利得 (L / R 共)

入力周波数	入力レベル	規定出力レベル	許容範囲
1kHz	- 10dBu	0dBu	0 ± 2dBu

2 - 4 .DIGITAL OUTの検査

条件 System Twoを使用します。
ANALOG INPUT L,R(XLR)から入力し、AES/EBU OUTから出力します。

a . WORD CLOCK INT96kHz

条件 WORD CLOCK INTは96kHzにします。

① 利得 (AES / EBU OUT)

入力周波数	入力レベル	規定出力レベル	許容範囲
1kHz	+ 4dBu	- 10dBFS	- 10 ± 2dBFS

② f 特 (AES/EBU OUT)

条件 許容範囲は1kHzを基準とします。

入力周波数	入力レベル	許容範囲
20Hz	+ 4dBu	- 1.0 ~ + 0.5dB
40kHz	+ 4dBu	- 1.0 ~ + 0.5dB

③ 歪率 (AES/EBU OUT)

入力周波数	出力レベル	許容範囲
1kHz	- 1dBFS	0.01%以下

b . WORD CLOCK INT48kHz

条件 WORD CLOCK INTは48kHzにします。

① 歪率(AES / EBU OUT)

入力周波数	出力レベル	許容範囲
1kHz	- 1dBFS	0.02%以下

2 - 5 .DIGITAL INの検査

条件 System Twoを使用します。
AES/EBU INから入力し、ANALOG OUT L,R(XLR)から出力します。
WORD CLOCKはAES/EBUを選択します。

設定 入力の切替

UTILITYキーを押しLCDに INPUT SOURCE が表示されたところで INCキーを押します。
“ * ”マークが DIGITAL に移動したら設定完了です。
BACKキーを押し、ワードクロックの切り替え操作をします。

a . 96kHz

条件 System Twoの周波数設定(Sample Rate)を96kHzにします。

① 利得 (L / R 共)

入力周波数	入力レベル	規定出力レベル	許容範囲
1kHz	- 10dBFS	+ 14dBu	+ 14 ± 2dBu

② f 特 (L / R 共)

条件 許容範囲は1kHzを基準とします。

入力周波数	入力レベル	許容範囲
20Hz	- 10dBFS	- 1.0 ~ + 0.5dB
40kHz	- 10dBFS	- 1.0 ~ + 0.5dB

③ 歪率 (L / R 共)

入力周波数	出力レベル	許容範囲
1kHz	+ 23dBu	0.01%以下

b . 48kHz

条件 System Twoの周波数設定(Sample Rate)を48kHzにします。

① 歪率 (L / R 共)

入力周波数	出力レベル	許容範囲
1kHz	+ 23dBu	0.02%以下

補足) このテスト後、再びUTILITYキーを押しLCDに INPUT SOURCE が表示されたところでDECキーを押します。
“ * ”マークが ANALOG に移動したら設定完了です。
BACKキーを押し、ワードクロックの切り替え操作をします。

2 - 6 .WORD CLOCK IN ,DIGITAL INのPLL動作範囲

条件 System Twoを使用します。

ANALOG INPUT L, R(XLR)から入力し、ANALOG OUTPUT L, R(XLR)から出力します。

WORD CLOCKは以下を選択します。

WORD CLOCK INの検査時 : WORD CLOCK

DIGITAL INの検査時 : AES/EBU

a . 96 kHz + 6% (101.76 kHz)

条件 System Twoの周波数設定(Sample Rate)を96kHz + 6%にします。

① 歪率 (WORD CLOCK IN ,DIGITAL IN共)

入力周波数	出力レベル	許容範囲
1kHz	+ 23dBu	0 .03%以下

b . 44.1 kHz - 10% (39.69 kHz)

条件 System Twoの周波数設定(Sample Rate)を44.1kHz - 10%にします。

① 歪率 (WORD CLOCK IN ,DIGITAL IN共)

入力周波数	出力レベル	許容範囲
1kHz	+ 23dBu	0 .03%以下

2 - 7 .ジッター測定

条件 System Twoを使用します。

Sec PKを選択します。

BW:700Hz to 100kHz を選択します。

AES/EBU OUTで検査します。

a . WORD CLOCK INT

条件 WORD CLOCKは、下記表の値を選択します。

① ジッター

WORD CLOCK	許容範囲
INT 44 .1 kHz	2nsec以下
INT 48 kHz	2nsec以下
INT 88 .2 kHz	2nsec以下
INT 96 kHz	2nsec以下

b . WORD CLOCK EXT

条件 WORD CLOCKは以下を選択します。

WORD CLOCK INの検査時 : WORD CLOCK

DIGITAL INの検査時 : AES/EBU

System Twoの周波数設定(Sample Rate)は、下記表の値を選択します。

① ジッター (WORD CLOCK IN ,DIGITAL IN共)

WORD CLOCK	許容範囲
EXT 44 .1 kHz	4nsec以下
EXT 48 kHz	4nsec以下
EXT 88 .2 kHz	4nsec以下
EXT 96 kHz	4nsec以下

2 - 8 .音だし

EFFECT機能(DSP6動作確認)を聴感で確認します。

ANALOG INPUT、ANALOG OUTPUT

条件 ・WORD CLOCK: INT96kHz

・ANALOG INPUT L,R(XLR) から音楽信号を入れ、下記のPRESETプログラムを順にリコールし、どのプログラムでも LEVEL METER の CLIP が点灯しないように INPUT VOLUME を調整しておきます。

なお、PRESETプログラムのリコール方法は、UP/DOWNキーを押し7セグに数字を点滅させ、RECALLキーを押します。

確認するPRESETプログラム

プログラム08: AMBIENCE

プログラム58: ROGER ON THE 12

プログラム61: SYMPHONIC

プログラム78: DYNA FILTER

検査 PRESETプログラムをリコールし、スピーカーで信号を最低15秒間確認します。

4種類のPRESETプログラム総てに対して行います。INPUT VOLUMEを操作して出力レベルが変化することを確認します。

判定基準1: EFFECT音が出ていることを確認します。

判定基準2: ノイズが含まれていないことを確認します。

■ TEST PROGRAM

● Preparation

1) Cables

XLR (AES/EBU): 1 pc.

MIDI: 1 pc.

USB: 1 pc.

FC5 or OPEN JACK: 1 pc.

2) Measuring Instruments

Oscillator (output impedance: 150 Ω)

Oscilloscope (input impedance: 100 kΩ or more)

3) Personal Computer (PC): DOS/V machine

Using the USB cable, connect the USB connector of the main unit and the PC. Make settings for the USB-MIDI driver on the PC.

For the USB driver, use a Windows 9x type one. (Use of the Windows 2000 or XP, USB driver does not provide proper operation.)



4) Settings for USB-MIDI driver

In the "control panel" display on the PC, double click on "USB-MIDI Driver" to start up the USB-MIDI driver and then make settings.

* Download the USB-MIDI driver from the YSISS Home Page.
 (YSISS URL >><http://plaza.yamaha.co.jp/ysiss/exindex.nsf>)

5) Program Version Check

If the main program is not the latest version, it must be upgraded to the latest program. For the methods to check the program version and to write, refer to "Method for Writing the Program" on page 49.

● Starting Testing

Turn on the power while pressing "UTILITY" and "NEXT" keys

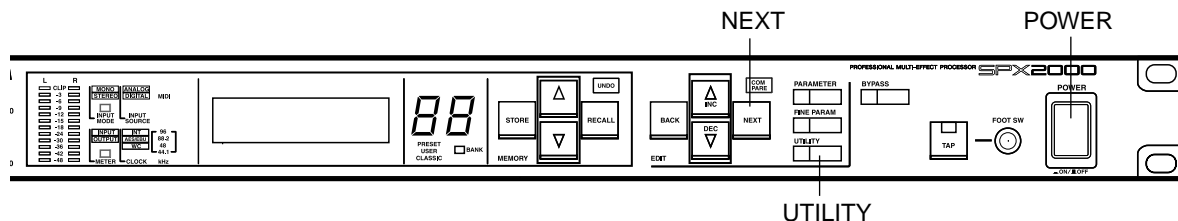

Entry screen

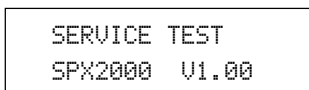

Displayed for a few seconds only.

● Operation Procedure

Key on panel	Function
[MEMORY UP]	Selection of test numbers in increasing direction
[MEMORY DOWN]	Selection of test numbers in decreasing direction
[RECALL]	Starting execution of the selected test number
[UNDO]	Forcing to stop the test being executed. * Stopping may not be available depending on test items.
[NEXT]	Manual input of OK in the test judged by a testing person.
[BACK]	Manual input of NG in the test judged by a testing person.

Example of panel display

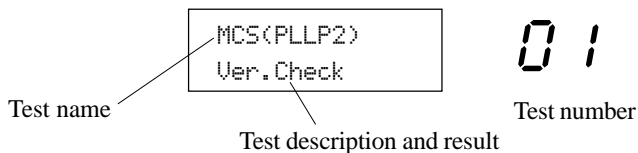

Meanings of displayed test results

OK	Normal	Details of the test that ended as normal are displayed on the left.
NG	Error	Details of the test in which an error occurred are displayed on the left.
--	Not tested yet	

The test result is kept until the power is turned off. (It is cleared when the power is turned off.)

When re-testing, a new test result is written over the previous test result.

It is not possible to restore the "not tested" state for those items that have already been tested. ("not tested" state is restored when the power is turned off.)

The LCD back light is white while testing. (this is applicable to tests other than the back light test)

● List of check items

Item	Test name	Outline of check item	Judgment
1	MCS(PLL2)	Check the register of the gate array PLL2 by reading/writing.	Auto
2	BATT	Check the voltage of the back-up battery/	Auto
4	DSP6,SIO	Check the register of DSP6 by reading/writing and SIO connection.	Auto
5	MIDI	Check MIDI OUT → IN transmission and reception.	Auto
6	USB MIDI	Check the USB circuit by initializing it and then executing loopback on the external PC.	Auto
7	AES/EBU IN/OUT (DIO)	Check AES/EBU IN/OUT DIGITAL by executing loopback.	Semi-auto
8	WORD CLOCK	Count the Fs of the oscillator using WCLK IN and check the lock state of PLL.	Semi-auto
9	LCD	Check that the back-light lights up in each color and the entire screen is displayed in black and white.	Visual check
10	PANEL LED	Check that LEDs (including 7-segment LEDs) light up in the specified order.	Visual check
11	PANEL ALL LED	Check that all LEDs light up in respective colors,	Visual check
12	PANEL SW	Check switches by pressing them in the specified order,	Semi-auto
13	ANALOG IN/OUT	Check analog input/output.	Visual check
14	NG LOG	Check that a list of test numbers resulted in NG is displayed.	

● Outline of Tests

1. MCS (PLL2) test

Reg. (00, 0f, 10, 16) of PLL2 is read and written for comparison check. Reg.12 (Ver.) is read and displayed. A0..A4 and D0..D15 are checked.

Reg.12 cannot be checked automatically because it is a read only Reg.

Example of execution screen

```
MCS(PLL2)
OK
```

When testing starts, "testing..." appears on the screen.

"OK" is displayed when the MCS test ends with a satisfactory result and "NG" when it ends with an abnormality detected.

2. BATT test

The back-up battery is checked automatically with its voltage measured by A/D.

Example of execution screen

```
BATTERY
NG
```

When testing starts, "testing..." appears on the screen.

"OK" is displayed when the battery test ends with a satisfactory result and "NG" when the measured battery voltage is 2.8V or lower.

3. There is no test program specified for No. 3.

4. DSP6, SIO test

The register of DSP6 is read and written to check the condition of Data BUS and Address BUS.

The data is read and written in the DRAM of DSP6 via the register for the comparative check.

The OUT METER SIO connection of DSP6 is checked by sending and receiving the signal.

Example of execution screen

```
DSP6 bit23,3,0
NG
```

When testing starts, "testing..." appears on the screen.

"OK" is displayed when the DSP6 test ends with a satisfactory result and "NG" when it ends with an abnormality detected.

Caution

Cancellation of the test is invalid while it is being executed.

5. MIDI test

The character string "SCI2: TEST¥n" (¥n=0Ah) is sent from MIDI OUT to MIDI IN at 31.25 Kbps to check if the sent string and the received one are identical.

Preparation

Connect the MIDI OUT and MIDI IN connectors of the main unit.

Example of execution screen



If no signal is received, "NG" is displayed in about 2 seconds.

When testing starts, "testing..." appears on the screen.

"OK" is displayed when the MIDI test ends with a satisfactory result and "NG" when it ends with an abnormality detected.

Caution

Cancellation of the test is invalid while it is being executed.

6. USB MIDI test

After initialization of the USB, it is checked automatically using the loopback of the USB connected PC.

Preparation

Using the general purpose USB cable, connect the USB connector of the main unit and the PC.

Make USB-MIDI driver settings on the PC. (Thru On)

Example of execution screen

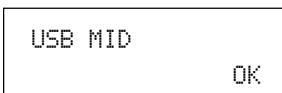

If no signal is received, "NG" is displayed after about 10 seconds. (The waiting time is set longer than that for the MIDI test because USB response may be slower depending on PCs.)

When testing starts, "testing..." appears on the screen.

"OK" is displayed when the MIDI test ends with a satisfactory result and "NG" when it ends with an abnormality detected.

Caution

Cancellation of this test is invalid while it is being executed.

7. AES/EBU IN/OUT (DIO) test

AES/EBU OUT DIGITAL → AES/EBU IN DIGITAL is checked by using SIO of DSP.

Preparation

Connect AES/EBU OUT DIGITAL and AES/EBU IN DIGITAL of the main unit.

Example of execution screen

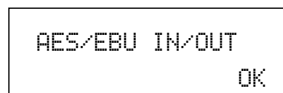

When testing starts, "testing..." appears on the screen.

When "DIO disconnect!" is displayed, disconnect the AES/EBU signal which is connected IN → OUT.

When preparation is completed, press the [NEXT] switch. To cancel this test in this stage, press either [UNDO] or [BACK] switch.

When the [NEXT] switch is pressed, testing starts again and "testing..." appears on the screen.

"OK" is displayed when the DIO test ends with a satisfactory result and "NG" when it ends with an abnormality detected.

Caution

1) DIR Lock flag is read by Gate Array (and checked after waiting for about 100mS after starting SIO transmission/reception).

2) DIT, DIR, CDIN, CDOOUT are read and written to check RUN bit (0 x 40 of Reg4)

8. WORD CLOCK test

The external oscillator OUT -> WORD CLOCK IN is counted by PLLP2 for automatic check.

(Fs=44.1/48/88.2/96kHz)

The lock condition of PLL is checked by reading the UNLOCK signal when the clock has been stabilized after the FS was changed (after about 200 ms).

The unlock condition of PLL is checked by pulling off the cable connected to WORD CLOCK IN.

Preparation

Connect the external oscillator and WORD CLOCK IN of the main unit.

Set the output clock of the external oscillator to 44.1kHz.

Example of execution screen

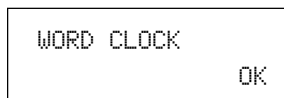

When testing starts, "testing..." appears on the screen.

When "Fs=48kHz OK?" appears on the screen, change the output clock of the external oscillator to Fs=48kHz. When preparation is completed, press the [NEXT] switch.

To cancel testing in this stage, press either [UNDO] or [BACK] switch.

When testing starts, "testing..." appears on the screen.

When "Fs=88.2kHz OK?" appears on the screen, change the output clock of the external oscillator to Fs=88.2kHz. When preparation is completed, press the [NEXT] switch. To cancel testing in this stage, press either [UNDO] or [BACK] switch.

When testing starts, "testing..." appears on the screen.

When "Fs=96kHz OK?" appears on the screen, change the output clock of the external oscillator to Fs=96kHz. When preparation is completed, press the [NEXT] switch. To cancel testing in this stage, press either [UNDO] or [BACK] switch.

When testing starts, "testing..." appears on the screen.

When "WC disconnect!" appears on the screen, disconnect the WORD CLOCK OUT signal which is connected IN -> OUT.

When preparation is completed, press the [NEXT] switch. To cancel testing in this stage, press either [UNDO] or [BACK] switch.

"OK" is displayed when the WORD CLOCK test ends with a satisfactory result and "NG" when it ends with an abnormality detected.

Caution

1) Various types of FS for PLL LOCK test are produced by the external oscillator.

FS=44.1kHz, 48kHz, 88.2kHz, 96kHz

9. LCD test

The LCD back-light (LED) is turned on in 3 colors respectively and checked visually.

The entire LCD screen is displayed in black and white alternately and checked visually.

Example of execution screen

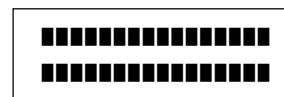

"Red" appears on the screen and the LCD back-color lights in red.

"Green" appears on the screen and the LCD back-color lights in green.

"Blue" appears on the screen and the LCD back-color lights in blue.

"White" appears on the screen and the LCD back-color lights in white.

If LCD back-color check result is satisfactory, press the [NEXT] switch but if it is not, press the [BACK] switch to make this test end.

When the above four colors have been confirmed and the [NEXT] switch is pressed at the fourth color, dots on the entire LCD screen are turned on and off repeatedly.

Check that the entire screen is displayed in black and white.

Check that no dot is missing on the entire screen.

Check that the display contrast is in good condition.

When the check results of above 3 items are satisfactory, press the [NEXT] switch but if they are not, press the [BACK] switch.

"OK" appears on the screen when the LCD test ends with a satisfactory result and "NG" when it ends with an abnormality detected.

10. PANEL LED test

Whether the LEDs on the panel light up in the specified order or not is checked visually.

Example of execution screen.

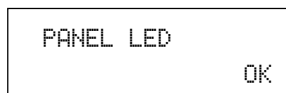

LEDs light up in the lighting order as specified.
All LEDs light up at the end of the lighting order.

If LEDs light properly, press the [NEXT] switch but if not press the [BACK] switch.

"OK" appears on the screen when the PANEL LED test ends with a satisfactory result and "NG" when it ends with an abnormality detected.

Caution

- 1) For the lighting order, refer to Fig. 1.
- 2) Only the meter L/R segments light up at the same time.
All the others light up independently.
- 3) The 7 seg LEDs light up in the order of 0, 1, 2 on the left and 0, 1, 2 on the right.

LED lighting order: Fig. 1

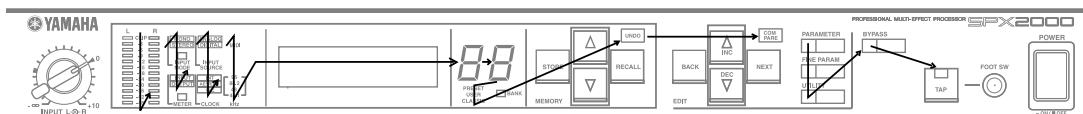

11. PANEL ALL LED test

When only red LEDs light up, check that no different color exists.

When only green LEDs light up, check that no different color exists.

When only orange LEDs light up, check that no different color exists.

Example of execution screen

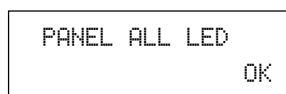

"RED LEDs" appears on the screen and all red LEDs light up.

"GREEN LEDs" appears on the screen and all red LEDs light up.

"ORANGE LEDs" appears on the screen and all red LEDs light up.

If LEDs light up by each color correctly, press the [NEXT] switch but if not, press the [BACK] switch to make this test end.

"OK" appears on the screen when the PANEL ALL LED test ends with satisfactory test result but "NG" when it ends with an abnormality detected.

12. PANEL SW test

Press all the switches on the panel in the specified order, and their response is checked automatically.

Example of execution screen

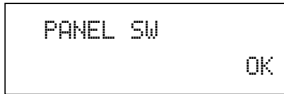

The name of the switch to be pressed is displayed on the LCD. After confirmation of that switch being pressed, the name of the switch to be pressed next is displayed. When "FOOT SW" appears at the end, insert the OPEN jack into the FOOT SW terminal.

The infinite loop is effective until the expected switch is pressed. In order to force testing to end, press the [BACK] switch to make the test in the NG state.

"OK" appears on the screen when the PANEL SW test ends with satisfactory test result but "NG" when it ends with an abnormality detected.

Caution

Refer to Fig. 2 for the operation procedure.

Button operation order: Fig. 2

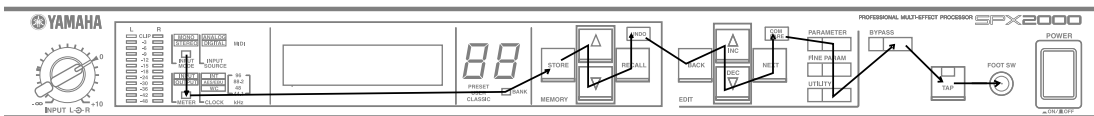

13. ANALOG IN/OUT test

Enter the test waveform through the ANALOG input and check the waveform at ANALOG output.

Example of execution screen

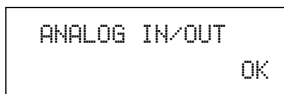

As DSP6 is 96kHz through setting, the DSP input/output waveforms should be identical.

If the check result is OK, press the [NEXT] switch and if NG, press the [BACK] switch.

"OK" appears on the screen when the ANALOG IN/OUT test ends with satisfactory test result but "NG" when it ends with an abnormality detected.

14. NG LOG

The numbers of tests that ended as NG are displayed as a list.

Among all tests that have been executed, the numbers of the tests whose final test result was NG are displayed.

Example of execution screen

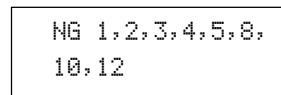

When some tests have not been executed and the executed tests have all resulted as OK, the numbers of those that have not been executed are displayed.

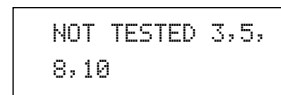

To return to the test menu number selection screen from the NG LOG display screen, press one of [UNDO], [RECALL] and [NEXT] switches.

テストプログラム

準備

1) ケーブル類

- XLR(AES/EBU): 1本
- MIDI: 1本
- USB: 1本
- FC5またはOPEN JACK: 1個

2) 測定器

- 発振器(出力インピーダンスは150 Ωとします。)
- オシロスコープ(入力インピーダンスは100k Ω以上とします。)

3) パーソナルコンピューター(PC) DOS/V機

- 本体のUSBコネクタとパソコンとをUSBケーブルで接続します。
- パソコンに、USB-MIDIドライバの設定をします。
- USBドライバーは、Windows9x系のものを用います。
- (Windows2000,XPのUSBドライバーでは、正常に動作をしません。)



4) USB-MIDIドライバの設定

- パソコンの「コントロールパネル」より「USB-MIDI Driver」をダブルクリックして、USB-MIDIドライバを起動した後、設定をします。

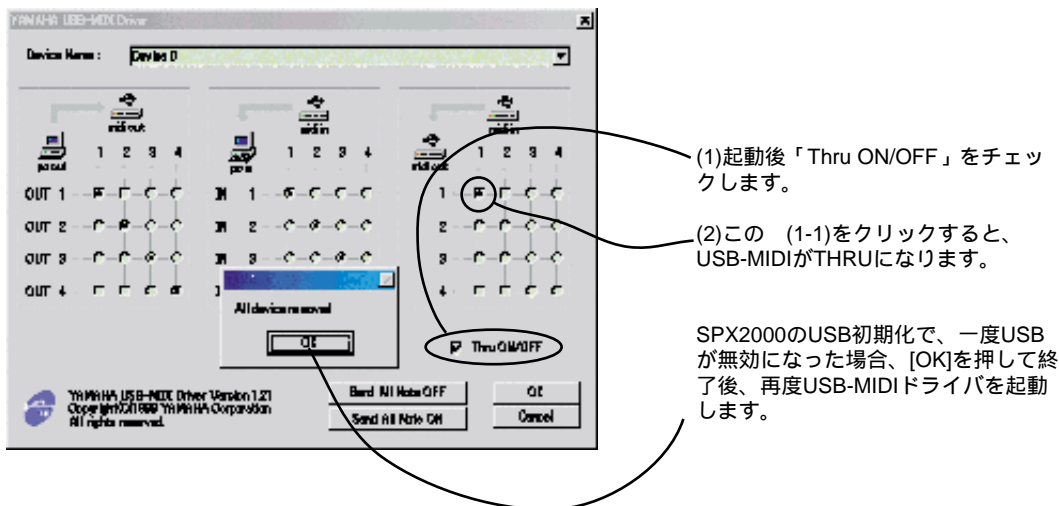

* USB-MIDIドライバーは、ヤマハCSセンターホームページのダウンロードページからダウンロードしてください。
(URL >><http://plaza.yamaha.co.jp/ysiss/index.nsf>)

5) プログラムバージョンの確認

- 本体プログラムが、最新バージョンになっていない場合、最新のプログラムにバージョンアップする必要があります。プログラムのバージョンの確認および書き込み方法は、49ページの「プログラムの書き込み」を参照してください。

起動方法

「UTILITY」⇨「NEXT」を押しながら電源ONします。

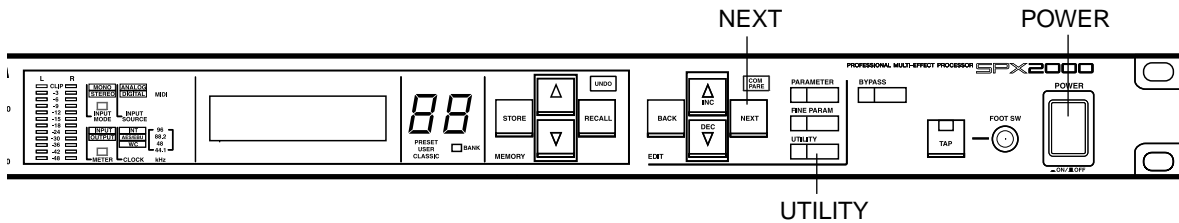

エントリー画面

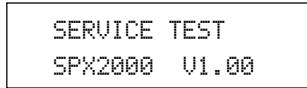

数秒だけ表示

操作方法

パネル上のキー	機能
[MEMORY UP]	テスト番号の順方向選択
[MEMORY DOWN]	テスト番号の逆方向選択
[RECALL]	選択したテスト番号の実行開始
[UNDO]	実行中のテストの強制中止 * 但しテスト項目によっては不可能なものもあります
[NEXT]	テスト者(人間)が判定するテストでの手動OK入力
[BACK]	テスト者(人間)が判定するテストでの手動NG入力

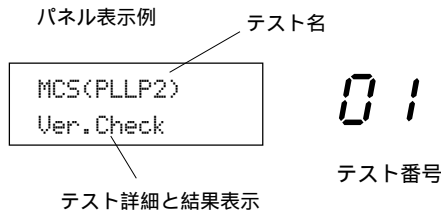

テスト結果表示の説明

OK	正常	左側に正常終了テスト詳細が表示されます
NG	エラー	左側にエラーが発生したテスト詳細が表示されます
--	未テスト	

テスト結果は、電源OFFされるまで保持されます(電源OFFで揮発します)。再テスト時は、以前のテスト結果に新しいテストが上書きされます。既にテストした項目を、未テスト状態に戻すことはできません(電源OFFで未テストに戻ります)。

テスト中のLCDバックライトは、白です(但しバックライトテスト以外)。

検査項目一覧

項目	検査名称	検査項目の概要	判定
1	MCS(PLL2)	ゲートアレー PLL2 のレジスタをW/Rし判定	自動
2	BATT	バックアップ用電池の電圧を判定	自動
4	DSP6,SIO	DSP6のレジスタをW/Rし判定、SIO接続判定	自動
5	MIDI	MIDI OUT-->INの送受信を判定	自動
6	USB MIDI	USB回路の初期化、外部PCでLoopBackし判定	自動
7	AES/EBU IN/OUT (DIO)	AES/EBU IN/OUT DIGITALをLoopBackし判定	半自
8	WORD CLOCK	オシレータのFsをWCLK INでカウント、PLLのLOCK判定	半自
9	LCD	バックライト色別点灯、全画面を黒・白表示	目視
10	PANEL LED	LED(7セグLEDを含む)が規定の順序で点灯	目視
11	PANEL ALL LED	全LEDの色別点灯	目視
12	PANEL SW	SWを規定順に押して判定	半自
13	ANALOG IN/OUT	アナログ入出力の検査	目視
14	NG LOG	テスト結果、NGだったテスト番号の一覧表示	

各テストの説明

1. MCS(PLL2) test

内容 PLL2のReg.(00, 0f, 10, 16)をW/Rして比較判定と、Reg.12(Ver.)の読出し表示します。
A0..A4とD0..D15をチェックします。
Reg.12はReadOnlyのReg.なので自動判定できません。

実行画面例

```
MCS(PLL2)
OK
```

テストが開始されると、“testing...”が表示されます。

MCSテストが正常終了すれば、“OK”が表示されます。
もし、異常終了すれば、“NG”が表示されます。

2. BATT test

内容 バックアップ用電池の電圧をA/Dで測定し自動判定します。

実行画面例

```
BATTERY
NG
```

テストが開始されると、“testing...”が表示されます。

バッテリーテストが正常終了すれば、“OK”が表示されます。
もし、バッテリー電圧が2.8V以下ならば、“NG”が表示されます。

3. NO. 3のテストプログラムはありません

4. DSP6, SIO test

内容 DSP6のRegisterをWrite/ReadしてDataBUS, Address BUSの良否を判定します。
DSP6 のDRAMにRegister経由でWrite/Readして比較判定します。
DSP6のOUT METER SIO結線を、信号の送受信で判定します。

実行画面例

```
DSP6 bit23,3,0
NG
```

テストが開始されると、“testing...”が表示されます。

DSP6 テストが正常終了すれば、“OK”が表示されます。
もし、異常終了すれば、“NG”が表示されます。

注意事項

このテスト中のキャンセル操作は無効です。

5. MIDI test

内容 MIDI OUT-->MIDI IN に31.25Kbpsで文字列‘SCI2: TEST ¥n’(¥n=0Ah)を送受信し、同一かどうかを検査します。

準備 本体のMIDI OUTとMIDI INコネクタを接続します。

実行画面例

```
MIDI
OK
```

信号が受信できない場合、約2秒後にNGの判定になります。

テストが開始されると、“testing...”が表示されます。

MIDI テストが正常終了すれば、“OK”が表示されます。
もし、異常終了すれば、“NG”が表示されます。

注意事項

このテスト中のキャンセル操作は無効です。

6. USB MIDI test

内容 USBを初期化後、USB接続したパソコンのLoopBackで自動判定をします。

準備 本体のUSBコネクタとパソコンとを汎用のUSBケーブルで接続します。
パソコンに、USB-MIDIドライバの設定をします。
(Thru On)

実行画面例

```
USB MID
OK
```

信号が受信できない場合、約10秒後にNGの判定になります。(パソコンのUSB反応が遅いものがあるため、MIDI testより待ち時間を長くしています)

テストが開始されると、“testing...”が表示されます。

USB テストが正常終了すれば、“OK”が表示されます。
もし、異常終了すれば、“NG”が表示されます。

注意事項

このテスト中のキャンセル操作は無効です。

7. AES/EBU IN/OUT(DIO) test

内容 AES/EBU OUT DIGITAL-->AES/EBU IN DIGITALをDSPのSIOを使用して判定します。

準備 本体のAES/EBU OUT DIGITALと、AES/EBU IN DIGITALを接続します。

実行画面例

```
AES/EBU IN/OUT
OK
```

テストが開始されると、“testing...”が表示されます。

“DIO disconnect!”と表示したら、IN->OUT 接続されているAES/EBU 信号を切り離します。

準備が終わったら、[NEXT] スイッチを押します。
ここでキャンセルをする場合、[UNDO] [BACK] スイッチのどちらかを押します。

[NEXT] スイッチが押されると、引き続きテストが始まり、“testing...”が表示されます。

DIO テストが正常終了すれば、“OK”が表示されます。
もし、異常終了すれば、“NG”が表示されます。

注意事項

- 1) DIR Lock flagは、Gate Array にてReadします(SIO送受信開始後約100ms待つて判定)。
- 2) DIT, DIR, CDIN, CDOOUTのWrite/ReadでRUN bit(Reg4の0x40)を確認します。

8. WORD CLOCK test

内容 外部オシレータOUT --> WORD CLOCK INをPLL2でカウントして自動判定します。

(Fs=44.1/48/88.2/96kHz)

PLLのLOCKチェックは、FS変更後クロックが安定するのを待って(約200ms後)、UNLOCK信号をReadし判定します。

PLLのUnLockチェックはWORD CLOCK INに接続されているケーブルを抜いて検査します。

準備 外部のオシレータと、本体のWORD CLOCK INを接続します。
外部オシレータの出力クロックを、44.1kHz に設定します。

実行画面例

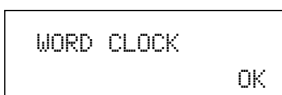

テストが開始されると、“testing...”が表示されます。

“Fs=48kHz OK?”と表示したら、外部オシレータの出力クロックを、Fs=48kHzに変更します。

準備が終わったら、[NEXT] スイッチを押します。
ここでキャンセルをする場合、[UNDO] [BACK] スイッチのどちらかを押します。

テストが開始されると、“testing...”が表示される。

“Fs=88.2kHz OK?”と表示したら、外部オシレータの出力クロックを、Fs=88.2kHzに変更します。

準備が終わったら、[NEXT] スイッチを押します。
ここでキャンセルをする場合、[UNDO] [BACK] スイッチのどちらかを押します。

テストが開始されると、“testing...”が表示されます。

“Fs=96kHz OK?”と表示したら、外部オシレータの出力クロックを、Fs=96kHzに変更します。

準備が終わったら、[NEXT] スイッチを押します。
ここでキャンセルをする場合、[UNDO] [BACK] スイッチのどちらかを押します。

テストが開始されると、“testing...”が表示されます。

“WC disconnect!”と表示したら、IN->OUT 接続されているWORD CLOCK OUT信号を切り離します。
準備が終わったら、[NEXT] スイッチを押します。
ここでキャンセルをする場合、[UNDO] か [BACK] スイッチのどちらかを押します。

WORD CLOCK テストが正常終了すれば、“OK”が表示されます。もし、異常終了すれば、“NG”が表示されます。

注意事項

- 1) PLLのLOCK検査用各種FSは、外部のオシレータで発生させます。
FS=44.1kHz, 48kHz, 88.2kHz, 96kHz

9. LCD test

内容 3色のLCDバックライト(LED)を、色別に点灯し、目視で確認します。
LCDの画面全体を黒と白の繰り返し表示にし、目視判定します。

実行画面例

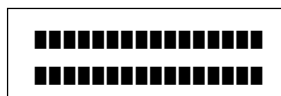

“Red”が表示されて、LCDのバックカラーが赤色に発色します。

“Green”が表示されて、LCDのバックカラーが緑色に発色します。

“Blue”が表示されて、LCDのバックカラーが青色に発色します。

“White”が表示されて、LCDのバックカラーが白色に発色します。

LCDのバックカラーの発光色に問題がなければ、[NEXT] スイッチを押します。

異常があれば、[BACK] スイッチを押してこのテストを終了します。

上記の4色が問題なく確認できて4色目で[NEXT] スイッチを押すと、LCDの全ドットON, OFFを繰り返し表示します。

全画面が、黒、白表示されることを確認します。

全画面に、ドット欠けがないことを確認します。

表示コントラストが正常であることを確認します。

上記3項目が正常に確認できたら、[NEXT] スイッチを押します。

異常があれば、[BACK] スイッチを押します。

LCDテストが正常終了すれば、“OK”が表示されます。
もし、異常終了すれば、“NG”が表示されます。

10. PANEL LED test

内容 パネル上のLEDが規定の順序で点灯するかを目視で確認します。

実行画面例

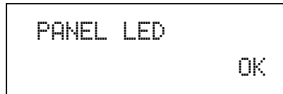

点灯順序に従い、LED を点灯します。

最後に、全ての LED を点灯します。

正常に点灯する場合、OKとして、[NEXT]を押します。

NGの場合、[BACK]を押します。

PANEL LED テストが正常終了すれば、“OK”が表示されます。もし、異常終了すれば、“NG”が表示されます。

注意事項

- 1) 点灯順序は図1を参照してください。
- 2) メーターL/Rのみ、左右同時に点灯します。それ以外は、単独点灯します。
- 3) 7segLEDは左0,1,2 右0,1,2の順で点灯します。

LED点灯順序:図1

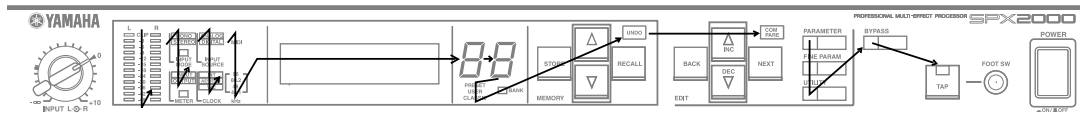

11. PANEL ALL LED test

内容 赤色のLEDのみ点灯するので、違う色がないかを確認します。

緑色のLEDのみ点灯するので、違う色がないかを確認します。

橙(オレンジ)色のLEDのみ点灯するので、違う色がないかを確認します。

実行画面例

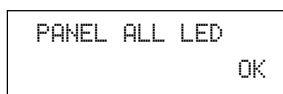

“RED LEDs”が表示されて、赤色LEDが全て発光します。

“GREEN LEDs”が表示されて、緑色LEDが全て発光します。

“ORANGE LEDs”が表示されて、橙(オレンジ)色LEDが全て発光します。

色別にLEDが発光するので、その都度、LEDが正常に発光していたら、[NEXT]スイッチを押します。

異常があれば、[BACK]スイッチを押してこのテストを終了します。

PANEL ALL LED テストが正常終了すれば、“OK”が表示されます。

もし、異常終了すれば、“NG”が表示されます。

12. PANEL SW test

内容 パネル上の全てのスイッチを規定順序通り押して反応するか検査します(自動判定)。

実行画面例

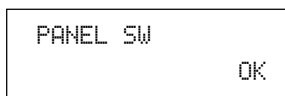

LCDに、押すべきスイッチ名称を表示します。

押されたことが確認できたら、次の押すべきスイッチ名称を表示します。

最後に、FOOT SWと表示されたら、OPEN JACKをFOOT SW端子に挿入します。

期待するスイッチが押されるまで無限ループです。

テストを強制終了したい場合は、[BACK]を押し、テストNGとします。

PANEL SW テストが正常終了すれば、“OK”が表示されます。もし、異常終了すれば、“NG”が表示される。

注意事項

操作順序は図2を参照してください。

ボタン操作順序: 図2

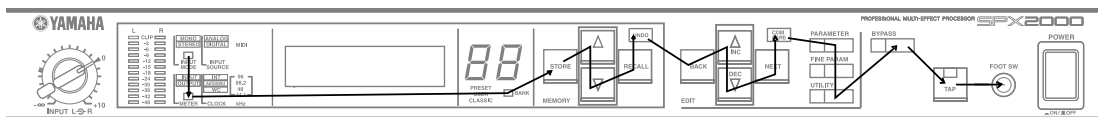

13. ANALOG IN/OUT test

内容 アナログ入力からテスト波形を入力し、アナログ出力波形を測定します。

実行画面例

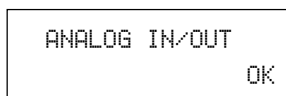

DSP6 は96kHzのスルー設定となるため、DSP入出力波形は同一です。

OKなら、[NEXT] を押します。

NGなら、[BACK] を押します。

ANALOG IN/OUT テストが正常終了すれば、“OK”が表示されます。もし、異常終了すれば、“NG”が表示されます。

14. NG LOG

内容 テスト結果が、NGであったテスト番号を、列挙表示します。

全テストが実施されて、テスト別に最後のテスト結果がNGであったテスト番号を列挙します。

画面実行例

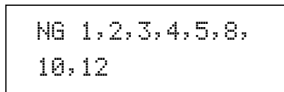

一部のテストが未テスト状態で、既に実施済みのテストが全てOKだった場合、未テスト番号を列挙します。

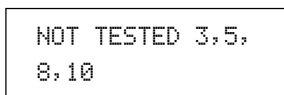

NG LOG 表示からテストメニュー番号選択に戻るには、[UNDO], [RECALL], [NEXT]いずれかのスイッチを押します。

■ WRITING PROGRAM(プログラムの書き込み)

If the main program is not the latest version, it must be upgraded to the latest program.

Download the latest program from the YSISS Home Page.

(YSISS URL >><http://plaza.yamaha.co.jp/ysiss/exindex.nsf>)

1. Confirming Program Version

While pressing the [UTILITY] key, turn on the main power to the SPX2000. Then, the version of the main program appears on the LCD screen.

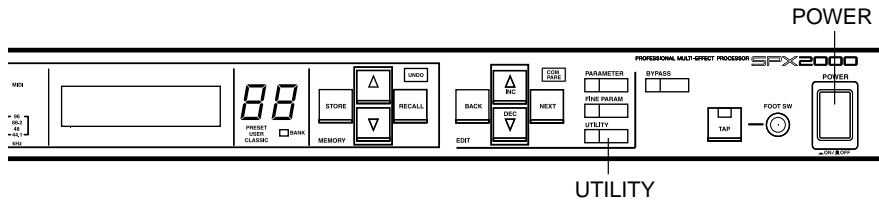

2. Writing Program

Use the following procedure to write the main program.

- Using the USB cable, connect the PC and SPX2000. (The YAMAHA USB-MIDI driver must be installed in the PC. Also, the setting of the USB-MIDI driver should be Through=Off.)
- While pressing the PARAMETER key and BYPASS key, turn on the main power to SPX2000. Keep pressing these keys until "OS UPDATE" appears on the screen of SPX2000.

Example of panel display / エントリー画面

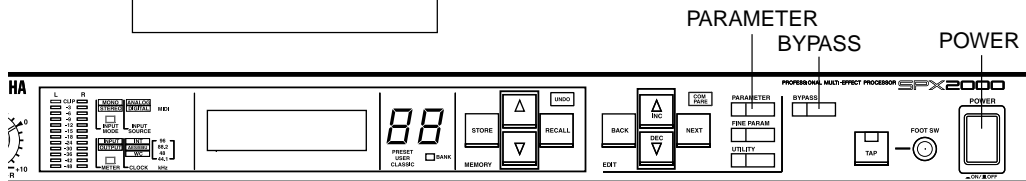
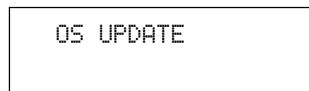

- Start up the version upgrading program (VerUp.exe).
- Press the [Browse] button and select the program of the main unit to be written (file name: SPX2K.pgm)
- Press the [Load] button to initiate writing of the program. While the program is being written, do not turn off the power to the main unit or disconnect the cable.
- Check the version of the program according to the method described in 1. Confirming Program Version above.

本体プログラムが、最新バージョンになっていない場合、最新のプログラムにバージョンアップします。最新のプログラムはYSISSホームページよりダウンロードしてください。

(URL >><http://plaza.yamaha.co.jp/ysiss/index.nsf>)

1. プログラムのバージョンの確認方法

UTILITYキーを押しながら SPX2000本体の電源を入れるとLCD画面に本体プログラムのバージョンが表示されます。

2. プログラムの書き込み方法

以下の手順に従い、本体プログラムを書き込みます。

- PCとSPX2000をUSBケーブルで接続します。(PCにYAMAHA USB-MIDIドライバーがインストールされていること。また、USB-MIDIドライバーの設定がThrough=Offであること。)
- PARAMETERキーとBYPASSキーを押しながらSPX2000本体の電源を入れます。キーは、SPX2000本体の画面に"OS UPDATE"と表示されるまで、押しつづけます。

- バージョンアッププログラム(VerUp.exe)を起動します。
- Browseボタンを押して書き込む本体プログラム(ファイル名はSPX2K.pgm)を選択します。
- Loadボタンを押すとプログラムの書き込みが開始されます。プログラム書き込み中は、本体電源を切ったり、ケーブルを抜いたりしないでください。
- 1の方法で、プログラムのバージョンを確認します。

■ BULK OUT (ALL)

(Transmitting SPX2000 data to another device)

You can transmit the SPX2000's system settings, MIDI program change tables, and effect data to another device.

This data will be transmitted from the port specified by the "MIDI PORT GENERAL" setting.

1 Select the "BULK OUT (ALL)" function

Press the [UTILITY] button several times to select "BULK OUT (ALL)."

```
BULK OUT(ALL)
PUSH INC
```

2 Start transmission

Press the [▲ INC] button to start transmission.

While the data is being transmitted, the display will indicate "Transmitting..."

When transmission is completed, the display will indicate "Completed!" for approximately one second.

NOTE: The INPUT MODE and METER settings are not included with the transmitted data.

(SPX2000 の情報を他の機器に転送する)

SPX2000 のシステム情報、MIDI プログラムチェンジテーブル、エフェクト情報をまとめて他の機器に転送します。

情報の転送には「MIDI PORT GENERAL」機能で設定したポートが使用されます。

- 「BULK OUT(ALL)」機能を選択する
[UTILITY]ボタンを何回か押して、「BULK OUT(ALL)」を選択します。

```
BULK OUT(ALL)
PUSH INC
```

- 情報の転送を開始する
[INC] ボタンを押して、転送を開始します。
情報の転送中はディスプレイに「Transmitting..」の文字が表示されます。
情報の転送が終了すると、ディスプレイに「Completed!」の文字が約1秒間表示されます。

NOTE: INPUT MODE、METER の情報は転送される内容に含まれません。

■ INITIALIZING THE SPX2000(初期化)

Here's how to return the SPX2000 to its factory-set condition.



The following procedure will erase all effects in the USER bank. If necessary, use the "BULK OUT (ALL)" function to back up your data before you proceed.

1 Turn off the power

If the SPX2000 is powered-on, turn the power off.

2 Prepare for initialization

While holding down the [STORE] button, turn on the power.

→The following screen will appear.

```
Factory Preset?
PUSH INC
```

3 Initialize

Press the [▲ INC] button to initialize the SPX2000.

If you decide not to initialize, press any button other than [▲ INC].

SPX2000 を工場出荷時の状態に戻します。



以下の操作をすると、USERバンクのエフェクトがすべて消去されます。初期化の前に必要に応じて、「BULK OUT(ALL)」機能でバックアップを取るなどしてください。

- 電源をOFFにする
SPX2000の電源がONになっている場合は、一度電源をOFFにします。
- 初期化の準備をする
[STORE]ボタンを押したまま、電源をONにします。
以下の画面が表示されます。

```
Factory Preset?
PUSH INC
```

- 初期化する
[INC] ボタンを押して、SPX2000を初期化します。
初期化をキャンセルする場合には、[INC] 以外のボタンを押してください。

■ ERROR MESSAGE LIST

Error message	Message content/Action
Low Battery!	The internal backup battery has run down. If the battery goes dead, the internal data will be lost. Press any button to cancel the error message. Then immediately use the “BULK OUT (ALL)” function to save the internal data on your computer or on external device. After you have saved the data, replace the backup battery (lithium battery).
MIDI Framing Error!	A MIDI framing error has occurred. Press any button to cancel the error message. Then try transmitting the MIDI data once again.
MIDI OUT is NOT Selected!	Since the “MIDI OUT/THRU” connector is set to “THRU,” MIDI messages cannot be transmitted. If you want to transmit MIDI messages, use the “MIDI OUT SETUP” function to set the [MIDI OUT/THRU] connector to “OUT.”
MIDI Overrun Error!	A MIDI overrun error has occurred. Press any button to cancel the error message. Then try transmitting the MIDI data once again.
MIDI Parity Error!	A MIDI parity error has occurred. Press any button to cancel the error message. Then try transmitting the MIDI data once again.
MIDI Rx Buffer Full!	The MIDI reception buffer is full. Press any button to cancel the error message. Then try transmitting the MIDI data once again. If the error occurs again, try increasing the spacing between the MIDI data that is transmitted, or take other measures to prevent a large amount of MIDI data from being transmitted at once.
NO FINE PARAMETER	This effect has no Fine parameters. Effects of the CLASSIC bank have no Fine parameters; this message will appear if you press the [FINE PARAM] button for an effect of the CLASSIC bank. Use the [PARAMETER] button to select Basic parameters.
Not Available in Compare Mode!	You pressed an unavailable button while comparing the effect (while the [COMPARE] LED is blinking). Press the [COMPARE] button to defeat Compare before you perform the desired operation.
Operation Locked!	The button etc. you attempted to operate has been disabled by the “OPERATION LOCK” function. Defeat the restriction as necessary.
PORT GENERAL is Selected OFF!	MIDI messages cannot be transmitted because the MIDI port (GENERAL) is turned OFF. If you want to transmit MIDI messages, set the “MIDI PORT GENERAL” setting to the port that you want to use for MIDI message transmission and reception.
U## Program is Empty!	There is no effect to recall. Please re-select an effect to recall.
Sync Error!	The clock of the received digital input signal differs from the SPX2000’s operating clock.
This BANK is Protected!	You selected the PRESET bank or CLASSIC bank as the effect store-destination. Since the PRESET bank and CLASSIC bank are read-only, you cannot change store to these effects, or change the effect name, protect setting, or display background color. Press any button to cancel the error message. Then select a store-destination from the USER bank.
This Program is Protected!	The effect store-destination is protected. Press any button to cancel the error message. Then defeat the protect setting as desired.
USB Rx Buffer Full!	The USB reception buffer is full. Press any button to cancel the error message. Then try transmitting the MIDI data once again. If the error occurs again, try increasing the spacing between the MIDI data that is transmitted, or take other measures to prevent a large amount of MIDI data from being transmitted at once.
WRONG WORD CLOCK!	The word clock signal from an external device has been interrupted, or is a frequency to which the SPX2000 cannot synchronize. Check whether there are any problems with the connection from the device supplying the word clock, and verify that the word clock settings are correct.

エラーメッセージリスト

エラーメッセージ	メッセージの内容/対処方法
Low Battery!	内蔵バックアップバッテリーが消費しています。 バッテリーが切れると内部のデータが消えてしまいます。どれかボタンを押してエラーを解除したあと、至急「BULK OUT(ALL) 機能」を使って、コンピューターなどの外部機器にデータを保存してください。また、データの保存が完了したら、バックアップバッテリー(リチウム電池)の交換をしてください。
MIDI Framing Error!	MIDI フレーミングエラーが発生しました。 どれかボタンを押してエラーを解除したあと、もう一度MIDIデータを送り直してみてください。
MIDI OUT is NOT Selected!	[MIDI OUT/THRU] 端子が「THRU」に設定されているため、MIDIメッセージが送信できません。 MIDIメッセージを送信する場合は「MIDI OUT SETUP」機能で[MIDI OUT/THRU] 端子を「OUT」に設定してください。
MIDI Overrun Error!	MIDIオーバーランエラーが発生しました。 どれかボタンを押してエラーを解除したあと、もう一度MIDIデータを送り直してみてください。
MIDI Parity Error!	MIDIパリティエラーが発生しました。 どれかボタンを押してエラーを解除したあと、もう一度MIDIデータを送り直してみてください。
MIDI Rx Buffer Full!	MIDIの受信バッファ一杯になりました。 どれかボタンを押してエラーを解除したあと、もう一度MIDIデータを送り直してみてください。 エラーが再発する場合にはMIDIデータの送信間隔をあげるなどして、一度に大量のMIDIデータが送り込まれないようにしてください。
NO FINE PARAMETER	FINEパラメーターがありません。 CLASSICバンクのエフェクトにはFINEパラメーターがありません。このため、CLASSICバンクのエフェクトで[FINE PARAM]ボタンを押すと、このメッセージが表示されます。[PARAMETER]ボタンを使って基本パラメーターを選択してください。
Not Available in Compare Mode!	エフェクト効果の比較中([COMPARE] LED 点滅中)に使用できないボタンを押しました。 [COMPARE] ボタンを押して比較を解除してからボタン操作をしてください。
Operation Locked!	今操作したボタン類は「OPERATION LOCK」機能によって、使用できなくなっています。必要に応じて操作の制限を解除してください。
PORT GENERAL is Selected OFF!	MIDIポート(GENERAL)の設定がOFFになっているため、MIDIメッセージが送信できません。 MIDIメッセージを送信する場合は「MIDI PORT GENERAL」機能でMIDIメッセージの送受信に使うポートを設定してください。
U## Program is Empty!	リコールするエフェクトがありません。リコールするエフェクトを選択しなおしてください。
Sync Error!	受信しているデジタル入力信号とSPX2000の動作しているCLOCKが違います。
This BANK is Protected!	エフェクトのストア先がPRESETバンクまたはCLASSICバンクになっています。 PRESETバンクやCLASSICバンクは読み出し専用のためエフェクトのストアやエフェクト名の変更、プロテクトの設定、ディスプレイ背景色の変更ができません。どれかボタンを押してエラーを解除したあと、USERバンクからストア先を選択してください。
This Program is Protected!	エフェクトのストア先にプロテクトがかかっています。 どれかボタンを押してエラーを解除したあと、必要に応じてプロテクトを解除してください。
USB Rx Buffer Full!	USBの受信バッファ一杯になりました。 どれかボタンを押してエラーを解除したあと、もう一度MIDIデータを送り直してみてください。 エラーが再発する場合にはMIDIデータの送信間隔をあげるなどして、一度に大量のMIDIデータが送り込まれないようにしてください。
WRONG WORD CLOCK!	外部からのワードクロック信号が途切れているか、SPX2000で同期可能な周波数ではありません。ワードクロックを供給する機器との接続やワードクロックの設定に問題がないかご確認ください。

■ MIDI IMPLEMENTATION CHART

YAMAHA [PROFESSIONAL MULTI-EFFECT PROCESSOR]

Date: 12 MAY 2003

Model: SPX2000

MIDI Implementation Chart

Version: 1.0

Function...		Transmitted	Recognized	Remarks
Basic Channel	Default	X	1-16	Memorized
	Changed	X	1-16	
Mode	Default	X	OMNI OFF/OMNI ON	Memorized
	Messages	X	X	
	Altered	*****	X	
Note Number	True Voice	X	0-127*1	*4
		*****	X	
Velocity	Note On	X	0 9nH, v=1-127*1	*4
	Note Off	X	X	
After	Key's Ch's	X	X	
		X	X	
Pitch Bend		X	X	
Control Change	0-32	X	0*1	0:Bank Select MSB
				1-30:*4
				31:Mix Balance
				32:Bank Select LSB
Program Change	:True#	X	0 0-127*1	Assignable Program Change Table

System Exclusive		0*2	0*2	*3
Common	:Song Pos.	X	X	
	:Song Sel.	X	X	
	:Tune	X	X	
System Real Time	:Clock	X	0	*4
	:Commands	X	X	
Aux Messages	:All Sound Of	X	X	
	:Reset All Cntrls	X	X	
	:Local ON/OFF	X	X	
	:All Notes OFF	X	X	
	:Active Sense	X	0	
	:Reset	X	0	
Notes		*1 receive if switch is on. *2 transmit/receive if exclusive switch is on. *3 Bulk Dump/Request, Parameter Change/Request *4 Effect Control(Depend On Program)		

Mode 1: OMNI ON, POLY
 Mode 3: OMNI OFF, POLY

Mode 2: OMNI ON, MONO
 Mode 4: OMNI OFF, MONO

O: Yes
 X: No

■ MIDI DATA FORMAT

1. Format summary

'tx' indicates that the SPX2000 can transmit the message. 'rx' indicates that the SPX2000 can receive the message.

1.1 CHANNEL MESSAGE

Command	rx/tx	function
8n NOTE OFF	rx	Control internal effects
9n NOTE ON	rx	Control internal effects
Bn CONTROL CHANGE	rx	Control parameters
Cn PROGRAM CHANGE	rx	Change programs

1.2 SYSTEM REALTIME MESSAGE

Command	rx/tx	function
F8 TIMING CLOCK	rx	MIDI clock
FE ACTIVE SENSING	rx	Check MIDI cable connections
FF RESET	rx	Clear running status

1.3 EXCLUSIVE MESSAGE

■ 1.3.1 Bulk dump

Command	rx/tx	function
F0 43 0n 7E ... F7 BULK DUMP DATA	rx/tx	Bulk dump data
F0 43 2n 7E ... F7 BULK DUMP REQUEST	rx	Bulk dump request

The SPX2000 handles the following types of data as bulk dumps.

Data name	rx/tx	function
S	rx/tx	System setup data and request
E	rx/tx	Effect program and request
P	rx/tx	Program change table and request

■ 1.3.2 Parameter Change

Command	rx/tx	function
F0 43 1n 1E 09 ... F7 PARAMETER CHANGE	rx/tx	Parameter changes specific to the SPX2000
F0 43 3n 1E 09 ... F7 PARAMETER REQUEST	rx	Parameter requests specific to the SPX2000

The SPX2000 handles the following types of data as parameter changes.

Type (HEX)	rx/tx	function
1 (01)	rx/tx	Edit buffer
3 (03)	rx/tx	System setup data
4 (04)	rx/tx	System backup data
16 (10)	rx/tx	Functions (recall, store, title, clear)
17 (11)	rx/tx	Functions (undo, compare)
18 (12)	rx	Functions (effect)
20 (14)	rx/tx	Functions (attribute (Protect), LCD Back Color)
33 (21)	rx/tx	Remote Meter

2. Format details

2.1 NOTE OFF (8n)

If the SPX2000 receives this message when a freeze-type effect has been recalled, it will stop playing the sampled data.

• Reception conditions

This message is received if the following two conditions are satisfied.

- 1) The "MIDI RECEIVE" setting is "NOTE ON/OFF = ON".
- 2) The channel on which the MIDI message is transmitted matches the SPX2000's MIDI channel, or the SPX2000's MIDI channel is set to OMNI.

• Format

```
STATUS 1000nnnn 8n Note off message
DATA   0nnnnnnn nn Note number
       0vvvvvvv vv Velocity (ignored)
```

2.2 NOTE ON (9n)

When the SPX2000 receives this message, it will control the recalled effect.

The effects that respond to this message and the controlled content are as follows.

DYNA.FILTER (P76) DYNA.FLANGE (P77) DYNA.PHASER (P78)	Modulation
FREEZE (P97) FREEZE A (C23) FREEZE B (C24)	Start recording, playing the sampled data
PITCH CHANGE A (C19) PITCH CHANGE D (C22)	Change pitch
REVERB & GATE (C18)	Open the gate

• Reception conditions

This message is received if the following two conditions are satisfied.

- 1) The "MIDI RECEIVE" setting is "NOTE ON/OFF = ON".
- 2) The channel on which the MIDI message is transmitted matches the SPX2000's MIDI channel, or the SPX2000's MIDI channel is set to OMNI.

• Format

```
STATUS 1001nnnn 9n Note on message
DATA   0nnnnnnn nn Note number
       0vvvvvvv vv Velocity (1-127:on, 0:off)
```

2.3 CONTROL CHANGE (Bn)

When the SPX2000 receives this message, it will operate in one of two ways. The operation will depend on the content of the first two bytes of data. If the data begins with a value of 01h-1Fh, the parameter specified by the control change parameter list will be controlled. If the data begins with a value of either 00h or 20h, the program change table (A/B/C) will be switched.

• Reception conditions

This message is received if the following two conditions are satisfied.

- 1) The "MIDI RECEIVE" setting is "CTL CHANGE = ON".
- 2) The channel on which the MIDI message is transmitted matches the SPX2000's MIDI channel, or the SPX2000's MIDI channel is set to OMNI.

• Format

If the data begins with 01h-1Fh

```
STATUS 1011nnnn Bn Control change
DATA   000nnnnn nn Control number (1-31)
       0vvvvvvv vv Control Value (0-127)
```

Equation for converting the control value into parameter data (CurValue)

paramSteps = paramMax - paramMin;
 curValue = (Control Value * paramSteps)/127;

If the data begins with 00h or 20h

STATUS	1011nnnn	Bn	Control change
DATA	00000000	00	Bank Select MSB
	00000000	00	Bank number MSB (0); fixed at 0
STATUS	1011nnnn	Bn	Control change
DATA	00100000	20	Bank Select LSB
	000000vv	vv	Bank number LSB (0, 1, 2); 0: table A, 1: table B, 2: table C
STATUS	1100nnnn	Cn	Program change
DATA	0vvvvvvv	vv	Program number (0-127)

2.4 PROGRAM CHANGE (Cn)

When the SPX2000 receives this message, it will recall the effect specified by the content of the program change table.

• Reception conditions

This message is received if the following two conditions are satisfied.

- 1) The "MIDI RECEIVE" setting is "PGM CHANGE = ON".
- 2) The channel on which the MIDI message is transmitted matches the SPX2000's MIDI channel, or the SPX2000's MIDI channel is set to OMNI.

• Format

STATUS	1100nnnn	Cn	Program change
DATA	0nnnnnnn	nn	Program number (0-127)

2.5 TIMING CLOCK (F8)

This message is used for tempo synchronization of the effect. Twenty-four of these messages are received per quarter note.

• Reception conditions

This message is received if the "TEMPO SOURCE" setting is set to a tempo synchronization source of "MIDI."

• Format

STATUS	11111000	F8	Timing clock
--------	----------	----	--------------

2.6 ACTIVE SENSING (FE)

Once the SPX2000 has received this message, failure to receive a message of any kind for an interval longer than 400 ms will cause it to initialize MIDI communication settings such as running status.

• Format

STATUS	11111110	FE	Active sensing
--------	----------	----	----------------

2.7 SYSTEM RESET (FF)

When the SPX2000 receives this message, it will initialize MIDI communication settings such as running status.

• Format

STATUS	11111111	FF	System reset
--------	----------	----	--------------

2.8 SYSTEM EXCLUSIVE MESSAGE (F0)

■ 2.8.1 BULK DUMP/BULK DUMP REQUEST

Bulk Dump messages are used to bulk dump SPX2000 data to a connected MIDI device, or to receive data from a connected MIDI device to overwrite internal settings of the SPX2000.

Bulk Dump Request messages request a bulk dump of data from the SPX2000.

• Reception conditions

This message is received if the following two conditions are satisfied.

- 1) The "MIDI RECEIVE" setting is "SYEX BLKDMP = ON".
- 2) The device number within the MIDI message matches the SPX2000's MIDI channel, or the SPX2000's MIDI channel is set to OMNI.

• Transmission conditions

This message is transmitted when either of the following conditions are met.

- The "BULK OUT (ALL)" function is executed to perform a bulk dump.
- A Bulk Dump Request message is received.

• Data conversion

The data portion is handled by converting seven words of 8-bit data into eight words of 7-bit data.

[Converting actual data into bulk data]

```
d[0~6]: Actual data
b[0~7]: Bulk data
b[0] = 0;
for( I=0; I<7; I++){
  if( d[I]&0x80){
    b[0] |= 1<<(6-I);
  }
  b[I+1] = d[I]&0x7F;
}
```

[Restoring bulk data into actual data]

```
d[0~6]: Actual data
b[0~7]: Bulk data
for( I=0; I<7; I++){
  b[0] <<= 1;
  d[I] = b[I+1]+(0x80&b[0]);
}
```

■ 2.8.1.1 System Setup Data Bulk Dump Format

This bulk-dumps the SPX2000's setup memory except for the program change table.

• Format

STATUS	11110000	F0	System exclusive message
ID No.	01000011	43	Manufacture's ID number (YAMAHA)
SUB STATUS	0000nnnn	0n	n=0-15 (Device number=Device No-1)
FORMAT No.	01111110	7E	Universal bulk dump
COUNT HIGH	0ccccccc	ch	data count = ch * 128 + cl
COUNT LOW	0ccccccc	cl	
	01001100	4C	'L'
	01001101	4D	'M'
	00100000	20	' '
	00100000	20	' '
	00111000	38	'8'
	01000100	44	'D'
	00110001	31	'1'
	00110001	31	'1'
DATA NAME	01010011	53	'S'
	00000010	02	
	00000000	00	No.256 = Current
BLOCK INFO.	0ttttttt	tt	total block number(minimum number is 0)
	0bbbbbbb	bb	current block number(0-total block number)
DATA	0ddddddd	ds	Setup data of block[bb]
	:	:	
	0ddddddd	de	
CHECK SUM	0eeeeeee	ee	ee=(Invert('L'+ c+de)+1)&0x7F
EOX	11110111	F7	End of exclusive

■ 2.8.1.2 System Setup Data Bulk Dump request Format

• Format

STATUS	11110000	F0	System exclusive message
ID No.	01000011	43	Manufacture's ID number (YAMAHA)
SUB STATUS	0010nnnn	2n	n=0-15 (Device number=Device No-1)
FORMAT No.	01111110	7E	Universal bulk dump
	01001100	4C	'L'
	01001101	4D	'M'
	00100000	20	' '
	00100000	20	' '
	00111000	38	'8'
	01000100	44	'D'
	00110001	31	'1'
	00110001	31	'1'
DATA NAME	01010011	53	'S'
	00000010	02	
	00000000	00	No.256 = Current
EOX	11110111	F7	End of exclusive

2.8.1.3 System Setup Data Bulk Dump request Format

This bulk-dumps the data of the specified effect.

Format

STATUS	11110000	F0	System exclusive message
ID No.	01000011	43	Manufacture's ID number (YAMAHA)
SUB STATUS	0000nnnn	0n	n=0-15 (Device number=Device No-1)
FORMAT No.	01111110	7E	Universal bulk dump
COUNT HIGH	00000000	00	data count = ch(0x00) * 128 + cl(0x72) = 114
COUNT LOW	01110010	72	
	01001100	4C	'L'
	01001101	4D	'M'
	00100000	20	' '
	00100000	20	' '
	00111000	38	'8'
	01000100	44	'D'
	00110001	31	'1'
	00110001	31	'1'
DATA NAME	01000101	45	'E'
	0mmmmmmmm	mh	0-220 (Program no.P1-97,C1-25,U1-99),256(EDIT BUFFER)
	0mmmmmmmm	m1	
BLOCK INFO.	0tttttttt	tt	total block number(minimum number is 0)
	0bbbbbbb	bb	current block number(0-total block number)
DATA	0ddddddd	ds	Effect Program data of block[bb]
	:	:	
	0ddddddd	de	
CHECK SUM	0eeeeeee	ee	ee=(Invert('L'+...de)+1)&0x7F
EOX	11110111	F7	End of exclusive

The second and third byte of DATA NAME specify the program number.

0:PRESET1 - 96:PRESET97
 97:CLASSIC1 - 121:CLASSIC25
 122:USER1 - 220:USER99
 256:EDIT BUFFER

For reception by the SPX2000, only USER 1-99 or EDIT BUFFER are valid. (120-220, 256)

2.8.1.4 Effect Program Bulk Dump request Format

The second and third byte of DATA NAME specify the program number.

Format

STATUS	11110000	F0	System exclusive message
ID No.	01000011	43	Manufacture's ID number (YAMAHA)
SUB STATUS	0010nnnn	2n	n=0-15 (Device number=Device No-1)
FORMAT No.	01111110	7E	Universal bulk dump
	01001100	4C	'L'
	01001101	4D	'M'
	00100000	20	' '
	00100000	20	' '
	00111000	38	'8'
	01000100	44	'D'
	00110001	31	'1'
	00110001	31	'1'
DATA NAME	01000101	45	'E'
	0mmmmmmmm	mh	0-220 (Program no.P1-97,C1-25,U1-99), 256(EDIT BUFFER)
	0mmmmmmmm	m1	
EOX	11110111	F7	End of exclusive

The second and third byte of DATA NAME specify the program number.

122:USER1 - 220:USER99
 256:EDIT BUFFER

2.8.1.5 Program change table Bulk Dump Format

This bulk-dumps the program change table data.

Format

STATUS	11110000	F0	System exclusive message
ID No.	01000011	43	Manufacture's ID number (YAMAHA)
SUB STATUS	0000nnnn	0n	n=0-15 (Device number=Device No-1)
FORMAT No.	01111110	7E	Universal bulk dump
COUNT HIGH	0ccccccc	ch	data count = ch * 128 + cl
COUNT LOW	0ccccccc	cl	

	01001100	4C	'L'
	01001101	4D	'M'
	00100000	20	' '
	00100000	20	' '
	00111000	38	'8'
	01000100	44	'D'
	00110001	31	'1'
	00110001	31	'1'
DATA NAME	01010000	50	'P'
	00000010	02	
	00000000	00	No.256 = Current
BLOCK INFO.	0tttttttt	tt	total block number (minimum number is 0)
	0bbbbbbb	bb	current block number (0 - total block number)
DATA	0ddddddd	ds	Program change table data of block[bb]
	:	:	
	0ddddddd	de	
CHECK SUM	0eeeeeee	ee	ee=(Invert ('L'+...+de)+1) &0x7F
EOX	11110111	F7	End of exclusive

2.8.1.6 Program change table Bulk Dump request Format

Format

STATUS	11110000	F0	System exclusive message
ID No.	01000011	43	Manufacture's ID number (YAMAHA)
SUB STATUS	0010nnnn	2n	n=0-15 (Device number=Device No-1)
FORMAT No.	01111110	7E	Universal bulk dump
	01001100	4C	'L'
	01001101	4D	'M'
	00100000	20	' '
	00100000	20	' '
	00111000	38	'8'
	01000100	44	'D'
	00110001	31	'1'
	00110001	31	'1'
DATA NAME	01010000	50	'P'
	00000010	02	
	00000000	00	No.256 = Current
EOX	11110111	F7	End of exclusive

2.8.2 Program change table Bulk Dump request Format

When the SPX2000 receives a Parameter Change message, the SPX2000 setting specified by the content will be controlled. When the SPX2000 receives a Parameter Change Request message, it will transmit a Parameter Change message in reply.

Reception conditions

This message is received if the following two conditions are satisfied.

- 1) The "MIDI RECEIVE" setting is "SYEX PRMCHG = ON".
- 2) The device number within the MIDI message matches the SPX2000's MIDI channel, or the SPX2000's MIDI channel is set to OMNI.

Transmission conditions PARAMETER CHANGE only

This message is transmitted when either of the following conditions are met.

- The SPX2000's state has changed due to a received Parameter Change
- A Parameter Change Request message is received

2.8.2.1 Parameter change (Edit Buffer)

This message modifies the value of a parameter in the edit buffer.

Format

STATUS	11110000	F0	System exclusive message
ID No.	01000011	43	Manufacture's ID number (YAMAHA)
SUB STATUS	0001nnnn	1n	n=0-15 (Device number=Device No-1)
GROUP ID	00011110	1E	MODEL ID (signal processor)
MODEL ID	00001001	09	SPX2000
ADDRESS	00000001	01	Edit Buffer
	0eeeeeee	ee	Element no.(if 'ee' is 0, 'ee' will be expanded to two bytes)
	0pppppppp	pp	Parameter no.
	0ccccccc	cc	Channel no.
DATA	0ddddddd	dd	data
	:	:	
EOX	11110111	F7	End of exclusive

■ 2.8.2.2 Parameter request (Edit Buffer)

• Format

```

STATUS      11110000  F0 System exclusive message
ID No.      01000011  43 Manufacture's ID number
              (YAMAHA)
SUB STATUS   0011nnnn  3n n=0-15 (Device number=
              Device No-1)
GROUP ID     00011110  1E MODEL ID (signal processor)
MODEL ID     00001001  09 SPX2000
ADDRESS      00000001  01 Edit Buffer
              0eeeeeee  ee Element no.(if 'ee' is 0,
              'ee' will be expanded to two
              bytes)
              0pppppppp  pp Parameter no.
              0ccccccc  cc Channel no.
EOX          11110111  F7 End of exclusive
    
```

■ 2.8.2.3 Parameter change (System Setup Memory)

This message modifies the value of a parameter in system setup memory.

• Format

```

STATUS      11110000  F0 System exclusive message
ID No.      01000011  43 Manufacture's ID number
              (YAMAHA)
SUB STATUS   0001nnnn  1n n=0-15 (Device number=
              Device No-1)
GROUP ID     00011110  1E MODEL ID (signal processor)
MODEL ID     00001001  09 SPX2000
ADDRESS      00000011  03 System Setup data
              0eeeeeee  ee Element no.(if 'ee' is 0,
              'ee' will be expanded to two
              bytes)
              0pppppppp  pp Parameter no.
              0ccccccc  cc Channel no.
              0ddddd  dd data
              :
              :
EOX          11110111  F7 End of exclusive
    
```

■ 2.8.2.4 Parameter request (System Setup Memory)

```

STATUS      11110000  F0 System exclusive message
ID No.      01000011  43 Manufacture's ID number
              (YAMAHA)
SUB STATUS   0011nnnn  3n n=0-15 (Device number=
              Device No-1)
GROUP ID     00011110  1E MODEL ID (signal processor)
MODEL ID     00001001  09 SPX2000
ADDRESS      00000011  03 System Setup data
              0eeeeeee  ee Element no.(if 'ee' is 0,
              'ee' will be expanded to two
              bytes)
              0pppppppp  pp Parameter no.
              0ccccccc  cc Channel no.
EOX          11110111  F7 End of exclusive
    
```

■ 2.8.2.5 Parameter change (System Backup Memory)

This message modifies the value of a parameter in system backup memory.

• Format

```

STATUS      11110000  F0 System exclusive message
ID No.      01000011  43 Manufacture's ID number
              (YAMAHA)
SUB STATUS   0001nnnn  1n n=0-15 (Device number=
              Device No-1)
GROUP ID     00011110  1E MODEL ID (signal processor)
MODEL ID     00001001  09 SPX2000
ADDRESS      00000011  04 System Backup data
              0eeeeeee  ee Element no.(if 'ee' is 0,
              'ee' will be expanded to two
              bytes)
              0pppppppp  pp Parameter no.
              0ccccccc  cc Channel no.
              0ddddd  dd data
              :
              :
EOX          11110111  F7 End of exclusive
    
```

■ 2.8.2.6 Parameter request (System Backup Memory)

• Format

```

STATUS      11110000  F0 System exclusive message
ID No.      01000011  43 Manufacture's ID number
              (YAMAHA)
SUB STATUS   0011nnnn  3n n=0-15 (Device number=
              Device No-1)
GROUP ID     00011110  1E MODEL ID (signal processor)
MODEL ID     00001001  09 SPX2000
ADDRESS      00000011  04 System Backup data
    
```

```

0eeeeeee  ee Element no.(if 'ee' is 0,
              'ee' will be expanded to two
              bytes)
0pppppppp  pp Parameter no.
0ccccccc  cc Channel no.
EOX        11110111  F7 End of exclusive
    
```

■ 2.8.2.7 Parameter change (Function call : Program store/recall)

When the SPX2000 receives this message, it will store or recall the specified effect, and will then use this message to transmit the state following the change. At this time, the device number will be the MIDI channel of the SPX2000. If the MIDI channel is OMNI, the device number will be 1.

• Format

```

STATUS      11110000  F0 System exclusive message
ID No.      01000011  43 Manufacture's ID number
              (YAMAHA)
SUB STATUS   0001nnnn  1n n=0-15 (Device number=
              Device No-1)
GROUP ID     00011110  1E MODEL ID (signal processor)
MODEL ID     00001001  09 SPX2000
ADDRESS      00010000  10 Function call
              00ffffff  ff function
              0mmmmmmmm  mh number High
              0mmmmmmmm  ml number Low
DATA        0ccccccc  ch channel High
              0ccccccc  cl channel Low
EOX          11110111  F7 End of exclusive
    
```

function	number	channel	rx/tx
Effect Program Recall	0x04	1-221	0 rx/tx
Effect Program Store	0x24	123-221	0 rx/tx

■ 2.8.2.8 Parameter change (Function call : title)

When the SPX2000 receives this message, it will edit the specified effect name, and will then use this message to transmit the state following the change. At this time, the device number will be the MIDI channel of the SPX2000. If the MIDI channel is OMNI, the device number will be 1.

• Format

```

STATUS      11110000  F0 System exclusive message
ID No.      01000011  43 Manufacture's ID number
              (YAMAHA)
SUB STATUS   0001nnnn  1n n=0-15 (Device number=
              Device No-1)
GROUP ID     00011110  1E MODEL ID (signal processor)
MODEL ID     00001001  09 SPX2000
ADDRESS      00010000  10 Function call
              01000100  44 Effect Program title
              0mmmmmmmm  mh number High
              0mmmmmmmm  ml number Low
DATA        0ddddd  dd title 1
              :
              :
              0ddddd  dd title x(depend on the pro-
              gram)
EOX          11110111  F7 End of exclusive
    
```

function	number	size	
Effect Program Title	0x44	1-221 (1-122:response only)	16

■ 2.8.2.9 Parameter request (Function call : title)

• Format

```

STATUS      11110000  F0 System exclusive message
ID No.      01000011  43 Manufacture's ID number
              (YAMAHA)
SUB STATUS   0011nnnn  3n n=0-15 (Device number=Device
              No-1)
GROUP ID     00011110  1E MODEL ID (signal processor)
MODEL ID     00001001  09 SPX2000
ADDRESS      00010000  10 Function call
              01000100  44 Effect Program title
              0mmmmmmmm  mh number High
              0mmmmmmmm  ml number Low
EOX          11110111  F7 End of exclusive
    
```

For the function and number, refer to the table in "2.8.2.8 Parameter change (Function call: title)."

2.8.2.10 Parameter change (Function call : Program clear)

When the SPX2000 receives this message, it will erase the specified effect name, and will then use this message to transmit the state following the change. At this time, the device number will be the MIDI channel of the SPX2000. If the MIDI channel is OMNI, the device number will be 1.

Format

```

STATUS      11110000  F0 System exclusive message
ID No.      01000011  43 Manufacture's ID number
              (YAMAHA)
SUB STATUS   0001nnnn  1n n=0-15 (Device number=Device
              No-1)
GROUP ID    00011110  1E MODEL ID (signal processor)
MODEL ID    00001001  09 SPX2000
ADDRESS     00010000  10 Function call
              01100100  64 Effect Program clear func-
              tion
              0mmmmmmmm  mh number High
              0mmmmmmmm  ml number Low
EOX         11110111  F7 End of exclusive
    
```

function	number
Effect Program Clear	0x64 123-221

2.8.2.11 Parameter change (Function call : Undo)

When the SPX2000 receives this message, it will perform the same operation as if the [UNDO] button had been pressed, and will then use this message to transmit the state following the change. At this time, the device number will be the MIDI channel of the SPX2000. If the MIDI channel is OMNI, the device number will be 1.

Format

```

STATUS      11110000  F0 System exclusive message
ID No.      01000011  43 Manufacture's ID number
              (YAMAHA)
SUB STATUS   0001nnnn  1n n=0-15 (Device number=Device
              No-1)
GROUP ID    00011110  1E MODEL ID (signal processor)
MODEL ID    00001001  09 SPX2000
ADDRESS     00010001  11 Function call
              00100010  24 Undo
              00000000  00
              00000000  00
              00000000  00
DATA        00000000  00
              00000000  00
EOX         11110111  F7 End of exclusive
    
```

2.8.2.12 Parameter change (Function call : Compare)

When the SPX2000 receives this message, it will perform the same operation as if the [COMPARE] button had been pressed, and will then use this message to transmit the state following the change. At this time, the device number will be the MIDI channel of the SPX2000. If the MIDI channel is OMNI, the device number will be 1.

Format

```

STATUS      11110000  F0 System exclusive message
ID No.      01000011  43 Manufacture's ID number
              (YAMAHA)
SUB STATUS   0001nnnn  1n n=0-15 (Device number=Device
              No-1)
GROUP ID    00011110  1E MODEL ID (signal processor)
MODEL ID    00001001  09 SPX2000
ADDRESS     00010001  11 Function call
              01000100  44 Compare
              00000000  00
              00000000  00
              00000000  00
DATA        00000000  00
              00000000  00
EOX         11110111  F7 End of exclusive
    
```

2.8.2.13 Parameter change (Function call : Event Effect)

When the SPX2000 receives this message while a freeze-type effect is recalled, it will perform the same operation as if the RECORD parameter or PLAY parameter is selected and the [▼DEC] button pressed. The contents of the function will determine whether the RECORD parameter or the PLAY parameter is selected.

Format

```

STATUS      11110000  F0 System exclusive message
ID No.      01000011  43 Manufacture's ID number
              (YAMAHA)
SUB STATUS   0001nnnn  1n n=0-15 (Device number=Device
              No-1)
GROUP ID    00011110  1E MODEL ID (signal processor)
    
```

```

MODEL ID    00001001  09 SPX2000
ADDRESS     00010010  12 Function call Effect Event
              0000ffff  0f function
              00000000  00
              0ppppppp  pp Release:0, Press:1
DATA        00000000  00
              0eeeeeee  ee Effect number (0)
EOX         11110111  F7 End of exclusive
    
```

function	channel
Freeze Play button	0x00 0
Freeze Record button	0x01 0

*This will not function if the effect type is wrong.

2.8.2.14 Parameter change (Function call: attribute(Protect))

When the SPX2000 receives this message, it will switch Protect on/off for the specified effect, and will then use this message to transmit the state following the change. At this time, the device number will be the MIDI channel of the SPX2000. If the MIDI channel is OMNI, the device number will be 1.

Format

```

STATUS      11110000  F0 System exclusive message
ID No.      01000011  43 Manufacture's ID number
              (YAMAHA)
SUB STATUS   0001nnnn  1n n=0-15 (Device number=Device
              No-1)
GROUP ID    00011110  1E MODEL ID (signal processor)
MODEL ID    00001001  09 SPX2000
ADDRESS     00010100  14 Function call
              00000100  04 attribute
              0mmmmmmmm  mh number High
              0mmmmmmmm  ml number Low
DATA        0ttttttt  tt attribute(protect:0x0001,
              normal:0x0000)
EOX         11110111  F7 End of exclusive
    
```

function	number
Effect Program Attribute	0x04 1-221(1-122:response only)

2.8.2.15 Parameter request (Function call: attribute(Protect))

Format

```

STATUS      11110000  F0 System exclusive message
ID No.      01000011  43 Manufacture's ID number
              (YAMAHA)
SUB STATUS   0011nnnn  3n n=0-15 (Device number=Device
              No-1)
GROUP ID    00011110  1E MODEL ID (signal processor)
MODEL ID    00001001  09 SPX2000
ADDRESS     00010100  14 Function call
              00000100  04 attribute
              0mmmmmmmm  mh number High
              0mmmmmmmm  ml number Low
EOX         11110111  F7 End of exclusive
    
```

For the function and number, refer to the table in "2.8.2.14 Parameter change (Function call: attribute (Protect))."

2.8.2.16 Parameter change (Function call: LCD Back Color)

When the SPX2000 receives this message, it will change the display background color of the specified effect, and will then use this message to transmit the state following the change. At this time, the device number will be the MIDI channel of the SPX2000. If the MIDI channel is OMNI, the device number will be 1.

Format

```

STATUS      11110000  F0 System exclusive message
ID No.      01000011  43 Manufacture's ID number
              (YAMAHA)
SUB STATUS   0001nnnn  1n n=0-15 (Device number=Device
              No-1)
GROUP ID    00011110  1E MODEL ID (signal processor)
MODEL ID    00001001  09 SPX2000
ADDRESS     00010100  14 Function call
              01100100  64 LCD Back Color
              0mmmmmmmm  mh number High
              0mmmmmmmm  ml number Low
DATA        0ccccccc  cc color(0:Green,1:Yellow,
              2:Magenta,3:Cyan,4:White)
              0ccccccc  cc
    
```

EOX	11110111	F7	End of exclusive
function			number
Effect Program LCD Back Color	0x64		1-221(1-122:response only)

2.8.2.17 Parameter request (Function call: LCD Back Color)

Format

STATUS	11110000	F0	System exclusive message
ID No.	01000011	43	Manufacture's ID number (YAMAHA)
SUB STATUS	0011nnnn	3n	n=0-15 (Device number=Device No-1)
GROUP ID	00011110	1E	MODEL ID (signal processor)
MODEL ID	00001001	09	SPX2000
ADDRESS	00010100	14	Function call
	01100100	64	LCD Back Color
	0mmmmmmmm	mh	number High
	0mmmmmmmm	ml	number Low
EOX	11110111	F7	End of exclusive

For the function and number, refer to the table in "2.8.2.16 Parameter change (Function call: LCD Back Color)."

2.8.2.18 Parameter change (Remote Meter)

When the SPX2000 receives a Parameter Request (Remote Meter) message, it will transmit this message. The content is data for the specified meter. This is transmitted at 50 msec intervals for ten seconds. If you want meter data to continue being transmitted, you must transmit a Request message at intervals of less than ten seconds. However if the port is being used for other communication, transmission of meter data may be interrupted.

The device number used when transmitting meter data will be the MIDI channel of the SPX2000. If the MIDI channel is OMNI, the device number will be 1.

When the SPX2000 receives a Request message with an Address UL = 0x7F, transmission of all meter data will be halted immediately. Transmission will also stop if the power is turned off and on again while transmitting meter data, or if the MIDI port setting is changed.

Format

STATUS	11110000	F0	System exclusive message
ID No.	01000011	43	Manufacture's ID number (YAMAHA)
SUB STATUS	0001nnnn	1n	n=0-15 (Device number=Device No-1)
GROUP ID	00011110	1E	MODEL ID (signal processor)
MODEL ID	00001001	09	SPX2000
ADDRESS	00100001	21	Remote meter
	0mmmmmmmm	mm	ADDRESS UL
	0mmmmmmmm	mm	ADDRESS LU
	0mmmmmmmm	mm	ADDRESS LL
DATA	0ddddd	dd	Data1 H
	0ddddd	dd	Data1 L
	:	:	
EOX	11110111	F7	End of exclusive

2.8.2.19 Parameter request (Remote Meter)

Format

STATUS	11110000	F0	System exclusive message
ID No.	01000011	43	Manufacture's ID number (YAMAHA)
SUB STATUS	0011nnnn	3n	n=0-15 (Device number=Device No-1)
GROUP ID	00011110	1E	MODEL ID (signal processor)
MODEL ID	00001001	09	SPX2000
ADDRESS	00100001	21	Remote meter
	0mmmmmmmm	mm	ADDRESS UL
	0mmmmmmmm	mm	ADDRESS LU
	0mmmmmmmm	mm	ADDRESS LL
	0ccccccc	ch	Count H
	0ccccccc	cl	Count L
EOX	11110111	F7	End of exclusive

PROFESSIONAL MULTI-EFFECT PROCESSOR

SFX2000

PARTS LIST

■ CONTENTS (目次)

OVERALL ASSEMBLY(総組立).....	2
ELECTRICAL PARTS(電気部品).....	5 - 15

Notes : DESTINATION ABBREVIATIONS

A : Australian model	M : South African model
B : British model	O : Chinese model
C : Canadian model	Q : South-east Asia model
D : German model	T : Taiwan model
E : European model	U : U.S.A. model
F : French model	V : General export model (110V)
H : North European model	W : General export model (220V)
I : Indonesian model	N,X: General export model
J : Japanese model	Y : Export model
K : Korean model	

■ WARNING

Components having special characteristics are marked  and must be replaced with parts having specification equal to those originally installed.

 印の部品は、安全を維持するために重要な部品です。交換する場合は、安全のために必ず指定の部品をご使用ください。

- The numbers "QTY" show quantities for each unit.
- The parts with "--" in "PART NO." are not available as spare parts.
- This mark "}" in the REMARKS column means these parts are interchangeable.
- The second letter of the shaded (■) part number is O, not zero.
- The second letter of the shaded (■) part number is I, not one.
- 部品価格ランクは、変更になることがあります。
- QTY欄に記されている数字は、各ユニット当たりの使用個数です。
- PART NO.が"--"の部品は、サービス用部品として準備されておりません。
- REMARKS欄の「}」マークの部品は、併用部品です。
- 網掛けの付いたPART NO. の2番目の文字は「ゼロ」ではなく「オー」です。
- 網掛けの付いたPART NO. の2番目の文字は「イチ」ではなく、「アイ」です。

OVERALL ASSEMBLY (総組立)

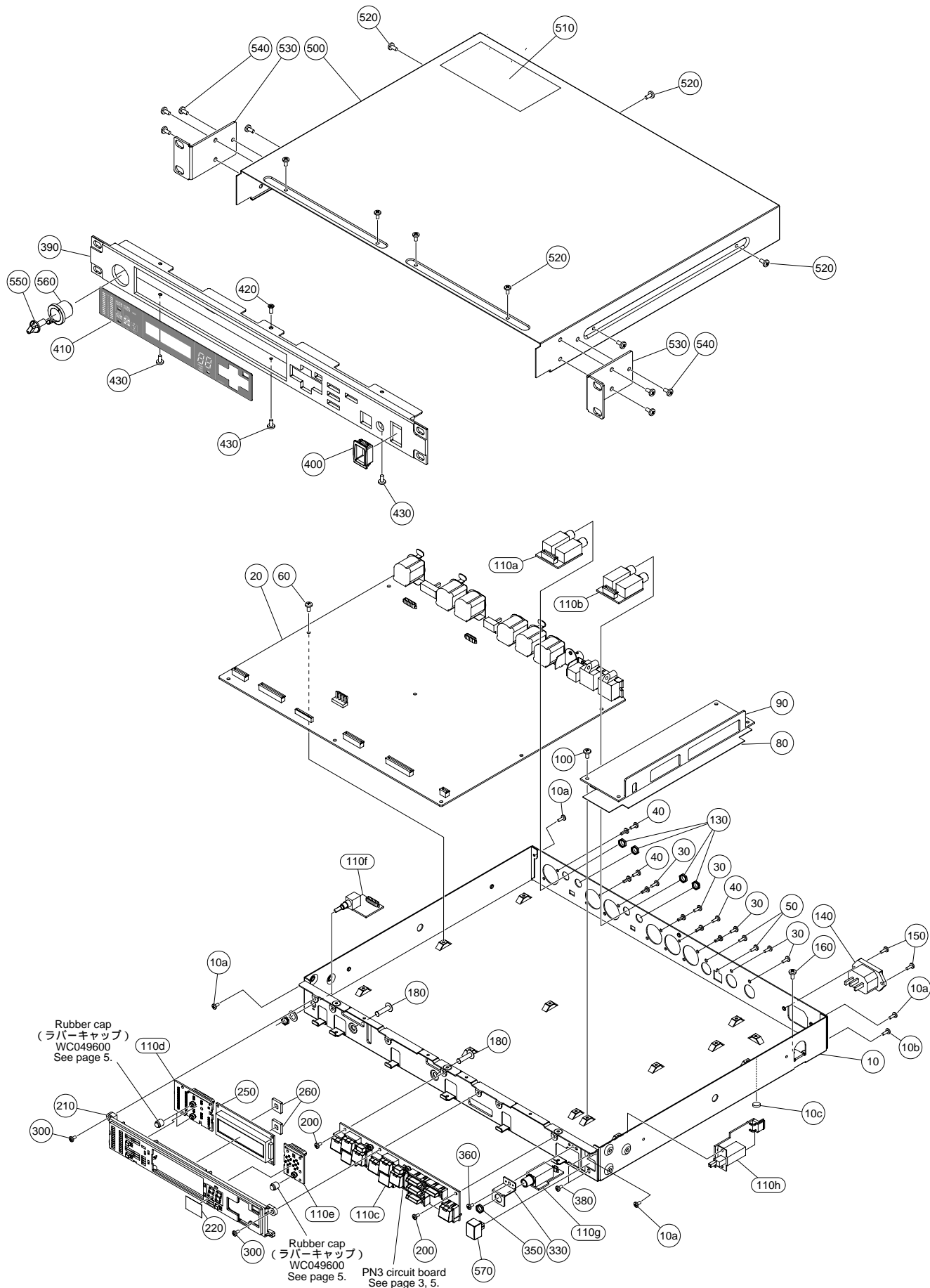

• Pic. 1 MAIN-POWER SUPPLY wiring

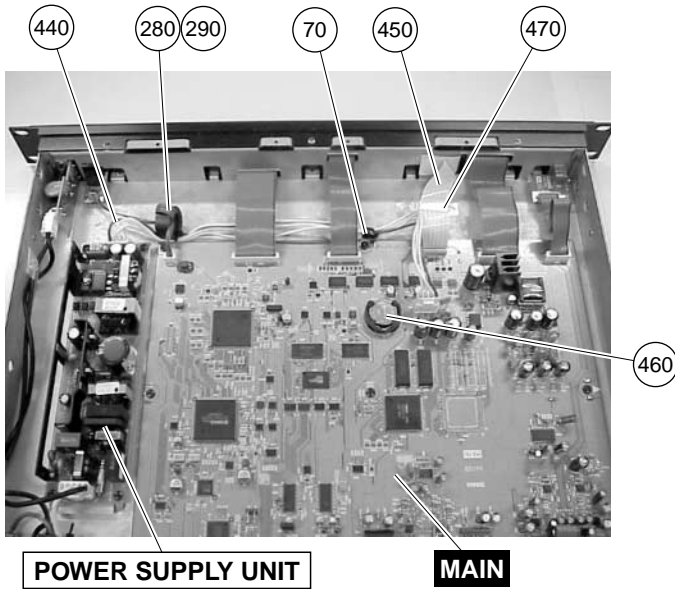

• Pic. 2 AC INLET-POWER wiring

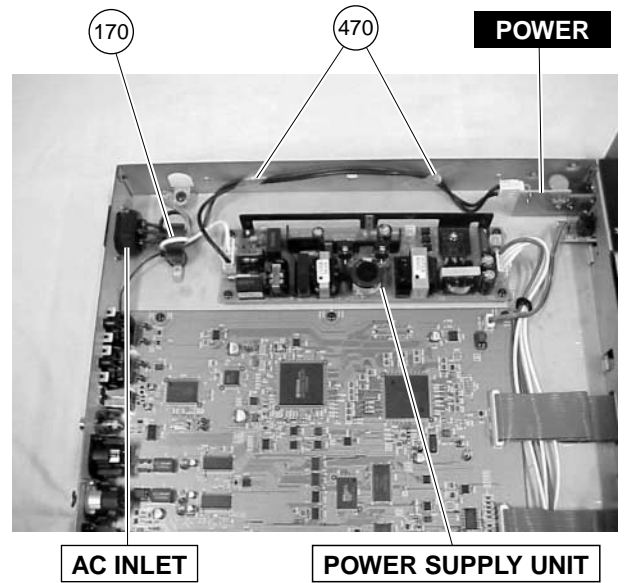

• AC inlet assembly

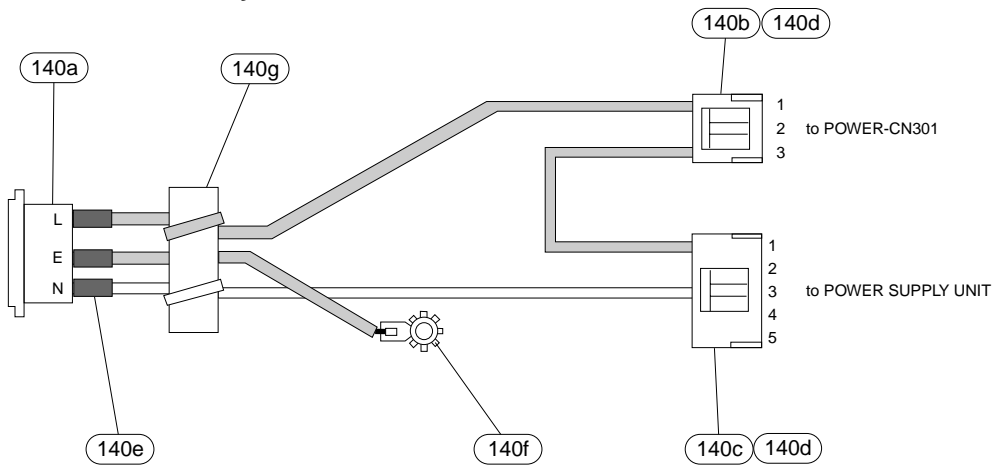

• PN3 circuit board (See page 5.)

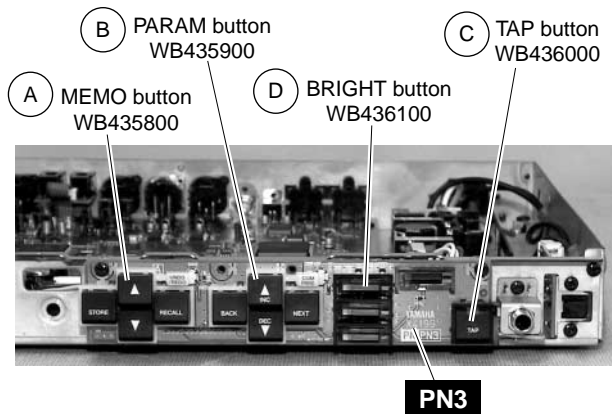

REF NO.	PART NO.	DESCRIPTION		部 品 名	REMARKS	QTY	RANK
*	10	WB424200	OVERALL ASSEMBLY	組 立	SPX2000 (WB42170)		
		--	Bottom Chassis	ボトムシャーシ A s s ' y			
	10a	EP630210	Bind Head Tapping Screw-S	+ バインド S タイ		4	01
	10b	EG340360	Bind Head Screw	+ バインド小ネジ			01
	10c	CB043750	Rubber Foot Black	T1.6 ゴ ム 脚		4	01
*	20	WB053000	Circuit Board	M A I N シ ー ト			
	30	EP600190	Bind Head Tapping Screw-B	+ バインド B タイ		8	01
	40	VB096700	Bind Head Tapping Screw-B	+ バインド B タイ		6	01
	50	EP630210	Bind Head Tapping Screw-S	+ バインド S タイ		2	01
	60	EP630210	Bind Head Tapping Screw-S	+ バインド S タイ		8	01
	70	CB040540	Cord Binder	S-72B L=50 束 線 止 め			01
*	80	WB451300	PS Cover	P S カ バ ー			
△	90	V9702900	Power Supply Unit	ZWS50AF-5/J 電 源 ユ ニ ッ ト			19
	100	EP630210	Bind Head Tapping Screw-S	+ バインド S タイ		4	01
	110	--	PN Circuit Board Assembly	P N シ ー ト A s s ' y	(WB43570)		
*	110a	AAAX51260	Circuit Board	J K I N シ ー ト	(WB42730)		
*	110b	AAAX51270	Circuit Board	J K O U T シ ー ト	(WB42740)		
*	110c	AAAX51240	Circuit Board	P N 3 シ ー ト	with Button (WB42710)		
*	110d	AAAX51220	Circuit Board	P N 1 シ ー ト	with Cap (WB42690)		
*	110e	AAAX51230	Circuit Board	P N 2 シ ー ト	with Cap (WB42700)		
*	110f	AAAX51280	Circuit Board	V O L シ ー ト	(WB42750)		
*	110g	AAAX51290	Circuit Board	F O O T S W シ ー ト	(WB42760)		
*	110h	AAAX51250	Circuit Board	P O W E R シ ー ト	(WB42720)		
	130	V2431400	Hexagonal Nut	9.0X11 特 殊 六 角 ナ ッ ト		4	01
*	140	WB440900	AC Inlet Assembly	AC INLET VH 3P/5P イ ン レ ッ ト A s s ' y			
△	140a	V5065200	AC Inlet	3P M1908-C A C イ ン レ ッ ト 3 P			03
	140b	LB015030	Connector Housing	VH 3P ハ ウ ジ ン グ			01
	140c	LB015050	Connector Housing	VH 5P ハ ウ ジ ン グ			01
	140d	LB101710	Connector Pin	SVH-21T-P1.1 圧 着 端 子		4	01
	140e	--	Tube Black	M5.0 ス ミ チ ュ ー プ ク ロ	(CH00428)		
	140f	--	Earth Lug	ア ー ス ラ グ T I 0 4 3 2	(WA11050)		
	140g	VC362700	Ferrite Core	FR25/15/12-1400L フ ェ ラ イ ト コ ア			04
	150	EP600190	Bind Head Tapping Screw-B	+ バインド B タイ		2	01
	160	EG340360	Bind Head Screw	+ バインド小ネジ			01
	170	CB069250	Cord Holder	BK-1 イ ン シ ュ ロ ッ ク タ イ			01
	180	WA624500	PCB Spacer	KGPS-16RF DPX1000 P C B ス ペ ー サ		2	01
	200	EP630210	Bind Head Tapping Screw-S	+ バインド S タイ		2	01
*	210	WB435200	LED Guide	L E D ガ イ ド			
*	220	WB550100	Film Red	カ ラ ー フ ィ ル ム			
*	250	WB448400	LCD	EW10212YMR 液 晶 デ ィ ス プ レ イ			
	260	--	Spacer	ス ペ ー サ	(WB43100)	2	
	280	CB069250	Cord Holder	BK-1 イ ン シ ュ ロ ッ ク タ イ			01
	290	VC362700	Ferrite Core	FR25/15/12-1400L フ ェ ラ イ ト コ ア			04
	300	EP630630	Bind Head Tapping Screw-S	+ バインド S タイ		2	01
	330	--	JACK Angle	J A C K ア ン グ ル	(WB45090)		
	350	V2431400	Hexagonal Nut	9.0X11 特 殊 六 角 ナ ッ ト			01
	360	EP630210	Bind Head Tapping Screw-S	+ バインド S タイ			01
	380	EP630210	Bind Head Tapping Screw-S	+ バインド S タイ		2	01
*	390	WB423800	Front Panel	フ ロ ン ト パ ネ ル 印 刷 品			
*	400	WB426500	Button Guide	ボ タ ン ガ イ ド P S W			
*	410	WB424600	Window	ウ イ ン ド ウ 印 刷 品			
*	420	WB451000	Flat Head Screw-S	3.0X6 MFAN2Y S タ イ ト 平 頭			
	430	EP630210	Bind Head Tapping Screw-S	+ バインド S タイ		3	01
*	440	WB440800	Connector Assembly	VH&VH 4P 340L 束 線 # 2 0			
*	450	WB639200	Cable	20P 180mm P=1.0 バ ン カ ー ド			
△	460	VN103500	Lithium Battery	CR2032 リ チ ウ ム 電 池			03
	470	VA126100	Adhesive Tape	12X50 粘 着 テ ー プ		3	03
*	500	WB424400	Top Cover	ト ッ プ カ バ ー プ レ ス 品			
	510	--	Label	MULTI ラ ベ ル 規 格	(WB55000)		
	520	EP630210	Bind Head Tapping Screw-S	+ バインド S タイ		9	01
*	530	WB424500	Angle Bracket, Rack	ラ ッ ク ア ン グ ル 印 刷 品		2	
	540	V1693100	Bind Head Tapping Screw-S	+ バインド S タイ		6	01
*	550	WB426700	Knob Internal	ノ ブ 内 印 刷 品	INPUT L		
*	560	WB426800	Knob External	ノ ブ 外 印 刷 品	INPUT R		
*	570	WB426600	Button	ボ タ ン P S W	POWER ON/OFF		
△			ACCESSORIES	付 属 品			
△		VQ240200	Adaptor, AC Cord	KPR-24 変 換 ア ダ プ タ ー	J		06
△		VT119800	AC Cord	J 7A 125V 3P 2.5m 電 源 コ ー ド	J		06
△		VB927800	AC Cord	CSA 電 源 コ ー ド	U,C,V		08
△		VB928000	AC Cord	VDE 電 源 コ ー ド	H,W,K		08
△		VP204400	AC Cord	BS 3P 電 源 コ ー ド	B		10

*: New Parts

RANK: Japan only

ELECTRICAL PARTS (電気部品)

REF NO.	PART NO.	DESCRIPTION	部 品 名	REMARKS	QTY	RANK
		ELECTRICAL PARTS	電 気 部 品	SPX2000		
*	AA51290	Circuit Board	FOOTSW	F O O T S W シ ー ト	(WB42760)(X4199B0)	
*	AA51260	Circuit Board	JKIN	J K I N シ ー ト	(WB42730)(X4199B0)	
*	AA51270	Circuit Board	JKOUT	J K O U T シ ー ト	(WB42740)(X4199B0)	
*	AA51220	Circuit Board	PN1	P N 1 シ ー ト	(WB42690)(X4199B0)	
*	AA51230	Circuit Board	PN2	P N 2 シ ー ト	(WB42700)(X4199B0)	
*	AA51240	Circuit Board	PN3	P N 3 シ ー ト	(WB42710)(X4199B0)	
*	AA51250	Circuit Board	POWER	P O W E R シ ー ト	(WB42720)(X4199B0)	
*	AA51280	Circuit Board	VOL	V O L シ ー ト	(WB42750)(X4199B0)	
*	WB053000	Circuit Board	MAIN	M A I N シ ー ト	(X4198B0)	
*	AA51290	Circuit Board	FOOTSW	F O O T S W シ ー ト	(WB42760)(X4199B0)	
*	AA51260	Circuit Board	JKIN	J K I N シ ー ト	(WB42730)(X4199B0)	
*	AA51270	Circuit Board	JKOUT	J K O U T シ ー ト	(WB42740)(X4199B0)	
*	AA51220	Circuit Board	PN1	P N 1 シ ー ト	(WB42690)(X4199B0)	
*	AA51230	Circuit Board	PN2	P N 2 シ ー ト	(WB42700)(X4199B0)	
*	AA51240	Circuit Board	PN3	P N 3 シ ー ト	(WB42710)(X4199B0)	
*	AA51250	Circuit Board	POWER	P O W E R シ ー ト	(WB42720)(X4199B0)	
*	AA51280	Circuit Board	VOL	V O L シ ー ト	(WB42750)(X4199B0)	
A	WB435800	Button, MEMO		ボ タ ン M E M O	STORE,RECALL,UP,DOWN, UNDO/REDO	
B	WB435900	Button, PARAM		ボ タ ン P A R A M	BACK,NEXT,INC,DEC, COMPARE	
C	WB436000	Button, TAP		ボ タ ン T A P	TAP	
D	WB436100	Button, BRIGHT		ボ タ ン 照 光	PARAMETER,FINE PARAM, UTILITY,BYPASS	4
E	WC049600	Rubber Cap		ラ バ ー キ ャ ッ プ	INPUT MODE,METER,BANK	3
10	VU073800	Jumper Wire	FVP=2.0C26SB14-140	2 6 7 8 ジ ャ ン パ ー ワ イ ヤ		
20	WB639500	Jumper Wire	FVP=2.0C26SB10-140	ジ ャ ン パ ー ワ イ ヤ		
30	WB639600	Jumper Wire	FVP=2.0C26SB15-140	ジ ャ ン パ ー ワ イ ヤ		
40	VV153500	Jumper Wire	FVP=2.0C26SB7-100	2 6 7 8 ジ ャ ン パ ー ワ イ ヤ		
50	WC109500	Jumper Wire	FVP=2.0C26SB2-220	ジ ャ ン パ ー ワ イ ヤ		
△	C301	V7682800	Capacitor	規 格 認 定 コ ン K H		01
	CN001	V1879200	Cable Holder	51048 14P TE	ケ ー ブ ル ホ ル ダ ー	01
	CN101	V1878800	Cable Holder	51048 10P TE	ケ ー ブ ル ホ ル ダ ー	01
	CN201	V1879300	Cable Holder	51048 15P TE	ケ ー ブ ル ホ ル ダ ー	01
	CN301	VP245600	Base Post Connector	VA 2P SE	ベ ー ス ツ キ ポ ス ト	01
	CN401	VK025100	Wire Trap	52147 7P TE	ワ イ ヤ ー ト ラ ッ プ	01
	CN501	VF728300	Wire Trap	52147 6P TE	ワ イ ヤ ー ト ラ ッ プ	01
	CN601	V1878500	Cable Holder	51048 7P TE	ケ ー ブ ル ホ ル ダ ー	01
	CN701	V1878000	Cable Holder	51048 2P TE	ケ ー ブ ル ホ ル ダ ー	01
	D001	VT332900	Diode	1SS355 TE-17	ダ イ オ ー ド	01
	D002	VT332900	Diode	1SS355 TE-17	ダ イ オ ー ド	01
	D101	VT332900	Diode	1SS355 TE-17	ダ イ オ ー ド	01
	D201	VT332900	Diode	1SS355 TE-17	ダ イ オ ー ド	01
	-214	VT332900	Diode	1SS355 TE-17	ダ イ オ ー ド	01
	EM701	V1243100	LC Filter	DSS6NB32A271Q93A	L C フ ィ ル タ ー	01
	JK401	LB302070	Phone Jack	HLJ0544 STREO	ホ ー ン コ ネ ク タ	03
	JK402	LB302070	Phone Jack	HLJ0544 STREO	ホ ー ン コ ネ ク タ	03
	JK501	LB302070	Phone Jack	HLJ0544 STREO	ホ ー ン コ ネ ク タ	03
	JK502	LB302070	Phone Jack	HLJ0544 STREO	ホ ー ン コ ネ ク タ	03
	JK701	LB301800	Phone Jack	HLJ0544 MONO.	ホ ー ン コ ネ ク タ	03
*	LD001	WC153200	LED (chip) Yellow	TLYV1020 J,K	チ ッ プ L E D キ	MIDI
*	LD002	WC153200	LED (chip) Yellow	TLYV1020 J,K	チ ッ プ L E D キ	CLOCK INT
	LD003	WA588100	LED (chip) Green	TLGU1020	チ ッ プ L E D ミ ド	CLIP L -48
	LD004	WA588100	LED (chip) Green	TLGU1020	チ ッ プ L E D ミ ド	CLIP L -24
*	LD005	WC153200	LED (chip) Yellow	TLYV1020 J,K	チ ッ プ L E D キ	CLIP L -9
*	LD006	WC153200	LED (chip) Yellow	TLYV1020 J,K	チ ッ プ L E D キ	METER INPUT
*	LD007	WC153200	LED (chip) Yellow	TLYV1020 J,K	チ ッ プ L E D キ	CLOCK AES/EBU
	LD008	WA588100	LED (chip) Green	TLGU1020	チ ッ プ L E D ミ ド	CLIP L -42
*	LD009	WC153200	LED (chip) Yellow	TLYV1020 J,K	チ ッ プ L E D キ	CLIP L -18
*	LD010	WC153200	LED (chip) Yellow	TLYV1020 J,K	チ ッ プ L E D キ	CLIP L -6
*	LD011	WC153200	LED (chip) Yellow	TLYV1020 J,K	チ ッ プ L E D キ	METER OUTPUT
*	LD012	WC153200	LED (chip) Yellow	TLYV1020 J,K	チ ッ プ L E D キ	CLOCK WC
	LD013	WA588100	LED (chip) Green	TLGU1020	チ ッ プ L E D ミ ド	CLIP L -36
*	LD014	WC153200	LED (chip) Yellow	TLYV1020 J,K	チ ッ プ L E D キ	CLIP L -15
*	LD015	WC153200	LED (chip) Yellow	TLYV1020 J,K	チ ッ プ L E D キ	CLIP L -3
*	LD016	WC153200	LED (chip) Yellow	TLYV1020 J,K	チ ッ プ L E D キ	INPUT SOURCE ANALOG
*	LD017	WC153200	LED (chip) Yellow	TLYV1020 J,K	チ ッ プ L E D キ	96kHz
	LD018	WA588100	LED (chip) Green	TLGU1020	チ ッ プ L E D ミ ド	CLIP L -30

*: New Parts

RANK: Japan only

REF NO.	PART NO.	DESCRIPTION	部 品 名	REMARKS	QTY	RANK
* LD019	WC153200	LED (chip) Yellow	TLYV1020 J,K	チ ッ プ L E D キ	CLIP L -12	
LD020	WA587900	LED (chip) Red	TLSU1020	チ ッ プ L E D ア カ	CLIP L 0	01
* LD021	WC153200	LED (chip) Yellow	TLYV1020 J,K	チ ッ プ L E D キ	INPUT SOURCE DIGITAL	
* LD022	WC153200	LED (chip) Yellow	TLYV1020 J,K	チ ッ プ L E D キ	88.2kHz	
LD023	WA588100	LED (chip) Green	TLGU1020	チ ッ プ L E D ミ ド	CLIP R -48	01
LD024	WA588100	LED (chip) Green	TLGU1020	チ ッ プ L E D ミ ド	CLIP R -24	01
* LD025	WC153200	LED (chip) Yellow	TLYV1020 J,K	チ ッ プ L E D キ	CLIP R -9	
* LD026	WC153200	LED (chip) Yellow	TLYV1020 J,K	チ ッ プ L E D キ	INPUT MODE MONO	
* LD027	WC153200	LED (chip) Yellow	TLYV1020 J,K	チ ッ プ L E D キ	48kHz	
LD028	WA588100	LED (chip) Green	TLGU1020	チ ッ プ L E D ミ ド	CLIP R -42	01
* LD029	WC153200	LED (chip) Yellow	TLYV1020 J,K	チ ッ プ L E D キ	CLIP R -18	
* LD030	WC153200	LED (chip) Yellow	TLYV1020 J,K	チ ッ プ L E D キ	CLIP R -6	
* LD031	WC153200	LED (chip) Yellow	TLYV1020 J,K	チ ッ プ L E D キ	INPUT MODE STEREO	
* LD032	WC153200	LED (chip) Yellow	TLYV1020 J,K	チ ッ プ L E D キ	44.1kHz	
LD033	WA588100	LED (chip) Green	TLGU1020	チ ッ プ L E D ミ ド	CLIP R -36	01
* LD034	WC153200	LED (chip) Yellow	TLYV1020 J,K	チ ッ プ L E D キ	CLIP R -15	
* LD035	WC153200	LED (chip) Yellow	TLYV1020 J,K	チ ッ プ L E D キ	CLIP R -3	
LD036	WA588100	LED (chip) Green	TLGU1020	チ ッ プ L E D ミ ド	CLIP R -30	01
* LD037	WC153200	LED (chip) Yellow	TLYV1020 J,K	チ ッ プ L E D キ	CLIP R -12	
LD038	WA587900	LED (chip) Red	TLSU1020	チ ッ プ L E D ア カ	CLIP R 0	01
* LD101	WC153200	LED (chip) Yellow	TLYV1020 J,K	チ ッ プ L E D キ	PRESET	
LD102	V3670000	LED Red	LT1D40A	L E D	7 SEG.	01
LD103	V3670000	LED Red	LT1D40A	L E D	7 SEG.	01
* LD104	WC153200	LED (chip) Yellow	TLYV1020 J,K	チ ッ プ L E D キ	USER	
LD105	V3670000	LED Red	LT1D40A	L E D	7 SEG.	01
LD106	V3670000	LED Red	LT1D40A	L E D	7 SEG.	01
* LD107	WC153200	LED (chip) Yellow	TLYV1020 J,K	チ ッ プ L E D キ	CLASSIC	
LD108	V3670000	LED Red	LT1D40A	L E D	7 SEG.	01
LD109	V3670000	LED Red	LT1D40A	L E D	7 SEG.	01
LD110	V3670000	LED Red	LT1D40A	L E D	7 SEG.	01
LD111	V3670000	LED Red	LT1D40A	L E D	7 SEG.	01
LD112	V3670000	LED Red	LT1D40A	L E D	7 SEG.	01
LD113	V3670000	LED Red	LT1D40A	L E D	7 SEG.	01
LD114	V3670000	LED Red	LT1D40A	L E D	7 SEG.	01
LD115	V3670000	LED Red	LT1D40A	L E D	7 SEG.	01
LD116	V3670000	LED Red	LT1D40A	L E D	7 SEG.	01
LD117	V3670000	LED Red	LT1D40A	L E D	7 SEG.	01
LD201	V5710700	LED	GL3JV804BOPE	L E D	UNDO/REDO	01
LD202	V5710700	LED	GL3JV804BOPE	L E D	COMPARE	01
* LD203	WC153200	LED (chip) Yellow	TLYV1020 J,K	チ ッ プ L E D キ	PARAMETER	
* LD204	WC153200	LED (chip) Yellow	TLYV1020 J,K	チ ッ プ L E D キ	FINE PARAM	
* LD205	WC153200	LED (chip) Yellow	TLYV1020 J,K	チ ッ プ L E D キ	UTILITY	
LD206	WA587900	LED (chip) Red	TLSU1020	チ ッ プ L E D ア カ	BYPASS	01
LD207	V3670200	LED Yellow	LT1H40A	L E D	TAP	01
SW001	VV056000	Tact Switch	SKQNAED010	タ ク ト S W	METER	01
SW002	VV056000	Tact Switch	SKQNAED010	タ ク ト S W	INPUT MODE	01
SW101	VV056000	Tact Switch	SKQNAED010	タ ク ト S W	BANK	01
SW201	VV056000	Tact Switch	SKQNAED010	タ ク ト S W	STORE	01
SW202	VV056000	Tact Switch	SKQNAED010	タ ク ト S W	DOWN	01
SW203	VV056000	Tact Switch	SKQNAED010	タ ク ト S W	UNDO/REDO	01
SW204	VV056000	Tact Switch	SKQNAED010	タ ク ト S W	INC	01
SW205	VV056000	Tact Switch	SKQNAED010	タ ク ト S W	NEXT	01
SW206	VV056000	Tact Switch	SKQNAED010	タ ク ト S W	PARAMETER	01
SW207	VV056000	Tact Switch	SKQNAED010	タ ク ト S W	UTILITY	01
SW208	VV056000	Tact Switch	SKQNAED010	タ ク ト S W	UP	01
SW209	VV056000	Tact Switch	SKQNAED010	タ ク ト S W	RECALL	01
SW210	VV056000	Tact Switch	SKQNAED010	タ ク ト S W	BACK	01
SW211	VV056000	Tact Switch	SKQNAED010	タ ク ト S W	DEC	01
SW212	VV056000	Tact Switch	SKQNAED010	タ ク ト S W	COMPARE	01
SW213	VV056000	Tact Switch	SKQNAED010	タ ク ト S W	FINE PARAM	01
SW214	VV056000	Tact Switch	SKQNAED010	タ ク ト S W	BYPASS	01
SW215	VV056000	Tact Switch	SKQNAED010	タ ク ト S W	TAP	01
△ SW301	V3127000	Push Switch	ESB92S23B J.U.C.S	プ ッ シ ュ S W	POWER ON/OFF	02
VR601	V4441400	Rotary Pot.	A10.0K RK09722	二 軸 ロ ー タ リ ー V R	INPUT L/R	06
* --	WB053000	Circuit Board	MAIN	M A I N シ ー ト	(X4198B0)	
	--	Vinyl Wire Black	AWG30 UL1571	ス ズ コ ー ト 線 黒	(V806100)	
5	VB659000	Bind Head Screw	3.0X8 MFZN2BL	+ バ イ ン ド 小 ネ ジ		01
10	VT645200	Jumper Wire	FVP=2.0C26SB7-60	2 6 7 8 ジ ャ ン パ ー ワ イ ヤ		01
* 20	VY689700	Jumper Wire	FVP=2.0C26SB6-60	2 6 7 8 ジ ャ ン パ ー ワ イ ヤ		

*: New Parts

RANK: Japan only

REF NO.	PART NO.	DESCRIPTION		部 品 名	REMARKS	QTY	RANK
BT001	VN103600	Battery Holder	CR2032	バッテリーホルダー			03
C001	US145100	Ceramic Capacitor-F (chip)	0.1000 25V Z	チップセラ (F)			01
C002	US145100	Ceramic Capacitor-F (chip)	0.1000 25V Z	チップセラ (F)			01
C003	UF018100	Electrolytic Cap. (chip)	100 6.3V	チップケミコン			01
C004	US145100	Ceramic Capacitor-F (chip)	0.1000 25V Z	チップセラ (F)			01
-010	US145100	Ceramic Capacitor-F (chip)	0.1000 25V Z	チップセラ (F)			01
C011	US063100	Ceramic Capacitor-B (chip)	1000P 50V K	チップセラ (B)			01
C012	US145100	Ceramic Capacitor-F (chip)	0.1000 25V Z	チップセラ (F)			01
-015	US145100	Ceramic Capacitor-F (chip)	0.1000 25V Z	チップセラ (F)			01
C016	UF046470	Electrolytic Cap. (chip)	4.7 25V	チップケミコン			01
C017	US145100	Ceramic Capacitor-F (chip)	0.1000 25V Z	チップセラ (F)			01
-026	US145100	Ceramic Capacitor-F (chip)	0.1000 25V Z	チップセラ (F)			01
C027	US062470	Ceramic Capacitor-SL(chip)	470P 50V J	チップセラ (S L)			01
C028	US062470	Ceramic Capacitor-SL(chip)	470P 50V J	チップセラ (S L)			01
C029	V4771700	Monolithic Ceramic Cap.	1.0 10V K	チップ積層セラコン			01
C030	V4771700	Monolithic Ceramic Cap.	1.0 10V K	チップ積層セラコン			01
C031	UF018100	Electrolytic Cap. (chip)	100 6.3V	チップケミコン			01
C032	US061220	Ceramic Capacitor-CH(chip)	22P 50V J	チップセラ (C H)			01
C033	US061220	Ceramic Capacitor-CH(chip)	22P 50V J	チップセラ (C H)			01
C036	US145100	Ceramic Capacitor-F (chip)	0.1000 25V Z	チップセラ (F)			01
-045	US145100	Ceramic Capacitor-F (chip)	0.1000 25V Z	チップセラ (F)			01
C101	US145100	Ceramic Capacitor-F (chip)	0.1000 25V Z	チップセラ (F)			01
-109	US145100	Ceramic Capacitor-F (chip)	0.1000 25V Z	チップセラ (F)			01
C201	US145100	Ceramic Capacitor-F (chip)	0.1000 25V Z	チップセラ (F)			01
-207	US145100	Ceramic Capacitor-F (chip)	0.1000 25V Z	チップセラ (F)			01
C208	UF017470	Electrolytic Cap. (chip)	47 6.3V	チップケミコン			01
C209	US135330	Ceramic Capacitor-F (chip)	0.3300 16V Z	チップセラ (F)			01
C210	US145100	Ceramic Capacitor-F (chip)	0.1000 25V Z	チップセラ (F)			01
C211	US135330	Ceramic Capacitor-F (chip)	0.3300 16V Z	チップセラ (F)			01
C212	US145100	Ceramic Capacitor-F (chip)	0.1000 25V Z	チップセラ (F)			01
-223	US145100	Ceramic Capacitor-F (chip)	0.1000 25V Z	チップセラ (F)			01
C224	US062560	Ceramic Capacitor-SL(chip)	560P 50V J	チップセラ (S L)			01
C225	US145100	Ceramic Capacitor-F (chip)	0.1000 25V Z	チップセラ (F)			01
-235	US145100	Ceramic Capacitor-F (chip)	0.1000 25V Z	チップセラ (F)			01
C236	UF118220	Electrolytic Cap. (chip)	220 6.3V UUR0J2	チップケミコン			01
C237	US145100	Ceramic Capacitor-F (chip)	0.1000 25V Z	チップセラ (F)			01
C238	US044220	Ceramic Capacitor-B (chip)	0.0220 25V K	チップセラ (B)			01
C239	UF118330	Electrolytic Cap. (chip)	330 6.3V UUR0J3	チップケミコン			01
C240	VR327300	Mylar Capacitor (chip)	0.0820 16V J	チップマイラー			01
C241	US044220	Ceramic Capacitor-B (chip)	0.0220 25V K	チップセラ (B)			01
C242	US044220	Ceramic Capacitor-B (chip)	0.0220 25V K	チップセラ (B)			01
C243	US145100	Ceramic Capacitor-F (chip)	0.1000 25V Z	チップセラ (F)			01
C244	V6200900	Capacitor	1.0000 16V M	チップフィルムコン			01
C245	US145100	Ceramic Capacitor-F (chip)	0.1000 25V Z	チップセラ (F)			01
-247	US145100	Ceramic Capacitor-F (chip)	0.1000 25V Z	チップセラ (F)			01
C301	US145100	Ceramic Capacitor-F (chip)	0.1000 25V Z	チップセラ (F)			01
-320	US145100	Ceramic Capacitor-F (chip)	0.1000 25V Z	チップセラ (F)			01
C401	V9074200	Mylar Capacitor (chip)	0.15 50V J	チップマイラー			01
C402	VS026900	Mylar Capacitor (chip)	0.0039 16V G	チップマイラー			01
C403	US145100	Ceramic Capacitor-F (chip)	0.1000 25V Z	チップセラ (F)			01
C404	US145100	Ceramic Capacitor-F (chip)	0.1000 25V Z	チップセラ (F)			01
C405	UF066100	Electrolytic Cap. (chip)	1 50V	チップケミコン			01
C406	US145100	Ceramic Capacitor-F (chip)	0.1000 25V Z	チップセラ (F)			01
C407	UF066100	Electrolytic Cap. (chip)	1 50V	チップケミコン			01
C408	US145100	Ceramic Capacitor-F (chip)	0.1000 25V Z	チップセラ (F)			01
-410	US145100	Ceramic Capacitor-F (chip)	0.1000 25V Z	チップセラ (F)			01
C411	UF066100	Electrolytic Cap. (chip)	1 50V	チップケミコン			01
C412	US145100	Ceramic Capacitor-F (chip)	0.1000 25V Z	チップセラ (F)			01
C413	US145100	Ceramic Capacitor-F (chip)	0.1000 25V Z	チップセラ (F)			01
C414	US061330	Ceramic Capacitor-CH(chip)	33P 50V J	チップセラ (C H)			01
C415	US145100	Ceramic Capacitor-F (chip)	0.1000 25V Z	チップセラ (F)			01
C416	US145100	Ceramic Capacitor-F (chip)	0.1000 25V Z	チップセラ (F)			01
C417	US061100	Ceramic Capacitor-CH(chip)	10P 50V D	チップセラ (C H)			01
C418	US061100	Ceramic Capacitor-CH(chip)	10P 50V D	チップセラ (C H)			01
C419	US145100	Ceramic Capacitor-F (chip)	0.1000 25V Z	チップセラ (F)			01
C420	US062680	Ceramic Capacitor-SL(chip)	680P 50V J	チップセラ (S L)			01
C421	US145100	Ceramic Capacitor-F (chip)	0.1000 25V Z	チップセラ (F)			01
-425	US145100	Ceramic Capacitor-F (chip)	0.1000 25V Z	チップセラ (F)			01
C426	UF037100	Electrolytic Cap. (chip)	10 16V	チップケミコン			01
C427	US145100	Ceramic Capacitor-F (chip)	0.1000 25V Z	チップセラ (F)			01

*: New Parts

RANK: Japan only

REF NO.	PART NO.	DESCRIPTION		部 品 名	REMARKS	QTY	RANK
C428	UF037100	Electrolytic Cap. (chip)	10 16V	チ ッ プ ケ ミ コ ン			01
C429	US145100	Ceramic Capacitor-F (chip)	0.1000 25V Z	チ ッ プ セ ラ (F)			01
C430	US145100	Ceramic Capacitor-F (chip)	0.1000 25V Z	チ ッ プ セ ラ (F)			01
C431	US061100	Ceramic Capacitor-CH(chip)	10P 50V D	チ ッ プ セ ラ (C H)			01
-433	US061100	Ceramic Capacitor-CH(chip)	10P 50V D	チ ッ プ セ ラ (C H)			01
C501	US145100	Ceramic Capacitor-F (chip)	0.1000 25V Z	チ ッ プ セ ラ (F)			01
C502	US145100	Ceramic Capacitor-F (chip)	0.1000 25V Z	チ ッ プ セ ラ (F)			01
C503	UF037470	Electrolytic Cap. (chip)	47 16V	チ ッ プ ケ ミ コ ン			01
C504	UF037470	Electrolytic Cap. (chip)	47 16V	チ ッ プ ケ ミ コ ン			01
C505	US145100	Ceramic Capacitor-F (chip)	0.1000 25V Z	チ ッ プ セ ラ (F)			01
-508	US145100	Ceramic Capacitor-F (chip)	0.1000 25V Z	チ ッ プ セ ラ (F)			01
C509	US064100	Ceramic Capacitor-B (chip)	0.0100 50V K	チ ッ プ セ ラ (B)			01
C510	US064100	Ceramic Capacitor-B (chip)	0.0100 50V K	チ ッ プ セ ラ (B)			01
C601	UU167470	Electrolytic Cap.	47.00 50.0V	ケ ミ コ ン F W			01
C602	UU167470	Electrolytic Cap.	47.00 50.0V	ケ ミ コ ン F W			01
C603	UU147220	Electrolytic Cap.	22.00 25.0V	ケ ミ コ ン F W			01
C604	US062150	Ceramic Capacitor-SL(chip)	150P 50V J	チ ッ プ セ ラ (S L)			01
C605	US061470	Ceramic Capacitor-CH(chip)	47P 50V J	チ ッ プ セ ラ (C H)			01
C606	US061330	Ceramic Capacitor-CH(chip)	33P 50V J	チ ッ プ セ ラ (C H)			01
C607	US062150	Ceramic Capacitor-SL(chip)	150P 50V J	チ ッ プ セ ラ (S L)			01
C608	US061330	Ceramic Capacitor-CH(chip)	33P 50V J	チ ッ プ セ ラ (C H)			01
C609	UU147220	Electrolytic Cap.	22.00 25.0V	ケ ミ コ ン F W			01
-611	UU147220	Electrolytic Cap.	22.00 25.0V	ケ ミ コ ン F W			01
C612	US062100	Ceramic Capacitor-SL(chip)	100P 50V J	チ ッ プ セ ラ (S L)			01
C613	US062100	Ceramic Capacitor-SL(chip)	100P 50V J	チ ッ プ セ ラ (S L)			01
C615	UU148100	Electrolytic Cap.	100.00 25.0V	ケ ミ コ ン F W			01
C617	UU148100	Electrolytic Cap.	100.00 25.0V	ケ ミ コ ン F W			01
C618	UU147220	Electrolytic Cap.	22.00 25.0V	ケ ミ コ ン F W			01
C619	US061470	Ceramic Capacitor-CH(chip)	47P 50V J	チ ッ プ セ ラ (C H)			01
C620	US062120	Ceramic Capacitor-SL(chip)	120P 50V J	チ ッ プ セ ラ (S L)			01
C621	US061470	Ceramic Capacitor-CH(chip)	47P 50V J	チ ッ プ セ ラ (C H)			01
C622	US062120	Ceramic Capacitor-SL(chip)	120P 50V J	チ ッ プ セ ラ (S L)			01
C623	UA353100	Mylar Capacitor	1000P 50V J	マ イ ラ ー コ ン			01
C626	US145100	Ceramic Capacitor-F (chip)	0.1000 25V Z	チ ッ プ セ ラ (F)			01
C627	UU147220	Electrolytic Cap.	22.00 25.0V	ケ ミ コ ン F W			01
C628	UU147470	Electrolytic Cap.	47.00 25.0V	ケ ミ コ ン F W			01
C629	US145100	Ceramic Capacitor-F (chip)	0.1000 25V Z	チ ッ プ セ ラ (F)			01
C630	UU148100	Electrolytic Cap.	100.00 25.0V	ケ ミ コ ン F W			01
C631	US145100	Ceramic Capacitor-F (chip)	0.1000 25V Z	チ ッ プ セ ラ (F)			01
* C632	WC153700	Electrolytic Cap.	22.00 50.0V	ケ ミ コ ン S M E			01
C633	US145100	Ceramic Capacitor-F (chip)	0.1000 25V Z	チ ッ プ セ ラ (F)			01
C634	US145100	Ceramic Capacitor-F (chip)	0.1000 25V Z	チ ッ プ セ ラ (F)			01
* C636	WC153600	Electrolytic Cap.	220.00 25.0V	ケ ミ コ ン S M E			01
C639	US145100	Ceramic Capacitor-F (chip)	0.1000 25V Z	チ ッ プ セ ラ (F)			01
C640	US145100	Ceramic Capacitor-F (chip)	0.1000 25V Z	チ ッ プ セ ラ (F)			01
C651	UU167470	Electrolytic Cap.	47.00 50.0V	ケ ミ コ ン F W			01
C652	UU167470	Electrolytic Cap.	47.00 50.0V	ケ ミ コ ン F W			01
C653	UU147220	Electrolytic Cap.	22.00 25.0V	ケ ミ コ ン F W			01
C654	US062150	Ceramic Capacitor-SL(chip)	150P 50V J	チ ッ プ セ ラ (S L)			01
C655	US061470	Ceramic Capacitor-CH(chip)	47P 50V J	チ ッ プ セ ラ (C H)			01
C656	US061330	Ceramic Capacitor-CH(chip)	33P 50V J	チ ッ プ セ ラ (C H)			01
C657	US062150	Ceramic Capacitor-SL(chip)	150P 50V J	チ ッ プ セ ラ (S L)			01
C658	US061330	Ceramic Capacitor-CH(chip)	33P 50V J	チ ッ プ セ ラ (C H)			01
C659	UU147220	Electrolytic Cap.	22.00 25.0V	ケ ミ コ ン F W			01
-661	UU147220	Electrolytic Cap.	22.00 25.0V	ケ ミ コ ン F W			01
C662	US062100	Ceramic Capacitor-SL(chip)	100P 50V J	チ ッ プ セ ラ (S L)			01
C663	US062100	Ceramic Capacitor-SL(chip)	100P 50V J	チ ッ プ セ ラ (S L)			01
C665	UU148100	Electrolytic Cap.	100.00 25.0V	ケ ミ コ ン F W			01
C667	UU148100	Electrolytic Cap.	100.00 25.0V	ケ ミ コ ン F W			01
C668	UU147220	Electrolytic Cap.	22.00 25.0V	ケ ミ コ ン F W			01
C669	US061470	Ceramic Capacitor-CH(chip)	47P 50V J	チ ッ プ セ ラ (C H)			01
C670	US062120	Ceramic Capacitor-SL(chip)	120P 50V J	チ ッ プ セ ラ (S L)			01
C671	US061470	Ceramic Capacitor-CH(chip)	47P 50V J	チ ッ プ セ ラ (C H)			01
C672	US062120	Ceramic Capacitor-SL(chip)	120P 50V J	チ ッ プ セ ラ (S L)			01
C673	UA353100	Mylar Capacitor	1000P 50V J	マ イ ラ ー コ ン			01
C676	US061100	Ceramic Capacitor-CH(chip)	10P 50V D	チ ッ プ セ ラ (C H)			01
C677	US061470	Ceramic Capacitor-CH(chip)	47P 50V J	チ ッ プ セ ラ (C H)			01
C678	US061220	Ceramic Capacitor-CH(chip)	22P 50V J	チ ッ プ セ ラ (C H)			01
* C701	WC153700	Electrolytic Cap.	22.00 50.0V	ケ ミ コ ン S M E			01
C702	UA355100	Mylar Capacitor	0.1000 50V J	マ イ ラ ー コ ン			01

*: New Parts

RANK: Japan only

REF NO.	PART NO.	DESCRIPTION		部 品 名	REMARKS	QTY	RANK
* C704	WC153700	Electrolytic Cap.	22.00 50.0V	ケミコン S M E			
C705	US145100	Ceramic Capacitor-F (chip)	0.1000 25V Z	チップセラ (F)			01
C706	US145100	Ceramic Capacitor-F (chip)	0.1000 25V Z	チップセラ (F)			01
C707	UA355100	Mylar Capacitor	0.1000 50V J	マイラ - コン			01
C708	UU147220	Electrolytic Cap.	22.00 25.0V	ケミコン F W			01
C709	UU147470	Electrolytic Cap.	47.00 25.0V	ケミコン F W			01
C710	UA355100	Mylar Capacitor	0.1000 50V J	マイラ - コン			01
C711	UA355100	Mylar Capacitor	0.1000 50V J	マイラ - コン			01
C712	UA353120	Mylar Capacitor	1200P 50V J	マイラ - コン			01
C714	UA352180	Mylar Capacitor	180P 50V J	マイラ - コン			01
C715	UA352180	Mylar Capacitor	180P 50V J	マイラ - コン			01
C719	US061330	Ceramic Capacitor-CH(chip)	33P 50V J	チップセラ (C H)			01
C720	US061330	Ceramic Capacitor-CH(chip)	33P 50V J	チップセラ (C H)			01
* C721	WC153900	Electrolytic Cap.	100.00 50.0V	ケミコン S M E			
* C722	WC153900	Electrolytic Cap.	100.00 50.0V	ケミコン S M E			
C724	UU148100	Electrolytic Cap.	100.00 25.0V	ケミコン F W			01
C726	UU148100	Electrolytic Cap.	100.00 25.0V	ケミコン F W			01
C727	UF037470	Electrolytic Cap. (chip)	47 16V	チップケミコン			01
* C728	UA352270	Mylar Capacitor	270P 50V J	マイラ - コン			
C729	UA352680	Mylar Capacitor	680P 50V J	マイラ - コン			01
C762	UA353120	Mylar Capacitor	1200P 50V J	マイラ - コン			01
C764	UA352180	Mylar Capacitor	180P 50V J	マイラ - コン			01
C765	UA352180	Mylar Capacitor	180P 50V J	マイラ - コン			01
C769	US061330	Ceramic Capacitor-CH(chip)	33P 50V J	チップセラ (C H)			01
C770	US061330	Ceramic Capacitor-CH(chip)	33P 50V J	チップセラ (C H)			01
* C771	WC153900	Electrolytic Cap.	100.00 50.0V	ケミコン S M E			
* C772	WC153900	Electrolytic Cap.	100.00 50.0V	ケミコン S M E			
C774	UU148100	Electrolytic Cap.	100.00 25.0V	ケミコン F W			01
C776	UU148100	Electrolytic Cap.	100.00 25.0V	ケミコン F W			01
* C778	UA352270	Mylar Capacitor	270P 50V J	マイラ - コン			
C779	UA352680	Mylar Capacitor	680P 50V J	マイラ - コン			01
C780	US061220	Ceramic Capacitor-CH(chip)	22P 50V J	チップセラ (C H)			01
* C801	WB828700	Electrolytic Cap.	470.00 50.0V	ケミコン A S F			
* C802	VR330000	Mylar Capacitor (chip)	0.0056 50V J	チップマイラ -			
* C803	WC153800	Electrolytic Cap.	47.00 50.0V	ケミコン S M E			
* C804	WB879900	Electrolytic Cap.	470.00 25.0V	ケミコン A S F			
* -806	WB879900	Electrolytic Cap.	470.00 25.0V	ケミコン A S F			
* C807	UA355160	Mylar Capacitor	0.1600 50V J	マイラ - コン			
* C808	UA355160	Mylar Capacitor	0.1600 50V J	マイラ - コン			
* C809	WC153600	Electrolytic Cap.	220.00 25.0V	ケミコン S M E			
* C810	WC153600	Electrolytic Cap.	220.00 25.0V	ケミコン S M E			
* C811	UA355160	Mylar Capacitor	0.1600 50V J	マイラ - コン			
* C812	WC153500	Electrolytic Cap.	330.00 16.0V	ケミコン S M E			
* C813	UA355180	Mylar Capacitor	0.1800 50V J	マイラ - コン			
* C814	UA355180	Mylar Capacitor	0.1800 50V J	マイラ - コン			
C815	UA355130	Mylar Capacitor	0.1300 50V J	マイラ - コン			01
* C816	WB879900	Electrolytic Cap.	470.00 25.0V	ケミコン A S F			
* C817	WB879900	Electrolytic Cap.	470.00 25.0V	ケミコン A S F			
C818	UA355150	Mylar Capacitor	0.1500 50V J	マイラ - コン			
* C819	WC153600	Electrolytic Cap.	220.00 25.0V	ケミコン S M E			
* C820	WB879900	Electrolytic Cap.	470.00 25.0V	ケミコン A S F			
CN002	VK024600	Wire Trap	52147 2P TE	ワイヤートラップ			01
* CN101	WA528800	FFC Connector	52806 20P TE	F F C コネクタ			
CN401	V9020800	USB Connector	USB 4P SE	U S B コネクタ B	TO HOST USB		
CN501	VK025800	Wire Trap	52147 14P TE	ワイヤートラップ			01
CN502	VF728200	Wire Trap	52147 10P TE	ワイヤートラップ			01
CN503	VF667600	Wire Trap	52147 15P TE	ワイヤートラップ			01
CN601	VI878500	Cable Holder	51048 7P TE	ケーブルホルダー			01
CN602	VK025100	Wire Trap	52147 7P TE	ワイヤートラップ			01
CN701	VI878400	Cable Holder	51048 6P TE	ケーブルホルダー			01
CN801	LB932040	Base Post Connector	VH 4P TE	ベースポスト			01
D001	V2376600	Diode	RB500V-40	ダイオード			01
D201	VT332900	Diode	1SS355 TE-17	ダイオード			01
D401	VT332900	Diode	1SS355 TE-17	ダイオード			01
D701	VT332900	Diode	1SS355 TE-17	ダイオード			01
-703	VT332900	Diode	1SS355 TE-17	ダイオード			01
D752	VT332900	Diode	1SS355 TE-17	ダイオード			01
D753	VT332900	Diode	1SS355 TE-17	ダイオード			01
D801	VT332900	Diode	1SS355 TE-17	ダイオード			01
D802	VT332900	Diode	1SS355 TE-17	ダイオード			01

*: New Parts

RANK: Japan only

REF NO.	PART NO.	DESCRIPTION	部 品 名	REMARKS	QTY	RANK
D803	V8409200	Diode	RB160L-60	ダイオード		01
D804	VS597600	Diode	RB160L-40 TE25	ダイオード		01
D805	V8409200	Diode	RB160L-60	ダイオード		01
D806	VS597600	Diode	RB160L-40 TE25	ダイオード		01
-808	VS597600	Diode	RB160L-40 TE25	ダイオード		01
DA401	VV556300	Diode Array	DAN217 0.3A X2	ダイオードアレイ		01
DA402	V9424900	Diode Array	1SS372 TE85L	ダイオードアレイ		01
DA403	V9424900	Diode Array	1SS372 TE85L	ダイオードアレイ		01
EM201	VD542700	LC Filter	DSS6NF31C223Q93A	LCフィルター EMI		01
EM202	VD542700	LC Filter	DSS6NF31C223Q93A	LCフィルター EMI		01
EM301	VD542700	LC Filter	DSS6NF31C223Q93A	LCフィルター EMI		01
EM401	VQ761400	EMI Filter (chip)	NFM3DCC101U1H3L	エミフィルチップ		01
EM402	V1243100	LC Filter	DSS6NB32A271Q93A	LCフィルター		01
EM403	V1243100	LC Filter	DSS6NB32A271Q93A	LCフィルター		01
EM601	V1243100	LC Filter	DSS6NB32A271Q93A	LCフィルター		01
EM602	V1243100	LC Filter	DSS6NB32A271Q93A	LCフィルター		01
EM651	V1243100	LC Filter	DSS6NB32A271Q93A	LCフィルター		01
EM652	V1243100	LC Filter	DSS6NB32A271Q93A	LCフィルター		01
EM701	V1243100	LC Filter	DSS6NB32A271Q93A	LCフィルター		01
EM702	V1243100	LC Filter	DSS6NB32A271Q93A	LCフィルター		01
EM751	V1243100	LC Filter	DSS6NB32A271Q93A	LCフィルター		01
EM752	V1243100	LC Filter	DSS6NB32A271Q93A	LCフィルター		01
EM801	VD542700	LC Filter	DSS6NF31C223Q93A	LCフィルター EMI		01
EM805	VD542700	LC Filter	DSS6NF31C223Q93A	LCフィルター EMI		01
-807	VD542700	LC Filter	DSS6NF31C223Q93A	LCフィルター EMI		01
IC001	X2157A00	IC	UPC2918T-E1	I	C	REGULATOR +1.8V
IC002	XR532A00	IC	NJM2904V(Te1)	I	C	OP AMP
IC003	XS775A00	IC	TC7SH04FU	I	C	INVERTER
IC004	X2081A00	IC	HD6417709SF133	I	C	CPU
IC005	XV891A00	IC	TC74VHC08FT	I	C	AND
IC006	X2163A00	IC	M62023FP	I	C	SYSTEM RESET
IC007	X3848A00	IC	S-80130ANMC-JCP-T2	I	C	SYSTEM RESET
IC009	XZ414B00	IC	W986416DH-7	I	C	SDRAM 64M
* IC010	X4916A00	IC	MX29LV160ABTC-7 FL	I	C	FLASH ROM 16M
* IC011	X3226A00	IC	M5M5V216ATP-55HI	I	C	SRAM 2M
IC012	XV945A00	IC	TC74VHC32FT	I	C	OR
IC101	X3097A00	IC	74LVX4245MTCX	I	C	TRANSCEIVER
IC102	X3097A00	IC	74LVX4245MTCX	I	C	TRANSCEIVER
IC103	XT744A00	IC	TC74VHCT245AFT	I	C	TRANSCEIVER
-106	XT744A00	IC	TC74VHCT245AFT	I	C	TRANSCEIVER
IC107	XV891A00	IC	TC74VHC08FT	I	C	AND
IC201	X3775A00	IC	S1L51252F32S000	I	C	PLL2(GATE ARRAY)
IC202	XW422A00	IC	M51953AFP	I	C	SYSTEM RESET
IC203	XT744A00	IC	TC74VHCT245AFT	I	C	TRANSCEIVER
IC204	XV064A00	IC	TLC2932IPWR	I	C	PLL
IC205	XG948E00	IC	YM3436DK	I	C	DIR2
IC206	XV892A00	IC	TC74VHC74FT	I	C	D-FF
IC207	X0195A00	IC	TC74VHC04FT	I	C	INVERTER
IC208	XV890A00	IC	TC74VHC14FT	I	C	INVERTER
* IC209	X2313A00	IC	TC74VHC00FT	I	C	NAND
IC210	XS775A00	IC	TC7SH04FU	I	C	INVERTER
IC301	XV077B00	IC	MSM514260E-60JS	I	C	DRAM 4M
IC302	XV077B00	IC	MSM514260E-60JS	I	C	DRAM 4M
IC303	XV988A00	IC	YSS910-S	I	C	DSP6
IC401	X2089A00	IC	CS8415A-CS	I	C	DIR
IC402	XS775A00	IC	TC7SH04FU	I	C	INVERTER
IC403	XW234A00	IC	TC74VHC244FT	I	C	BUFFER
IC404	X3586A00	IC	TC74VHCT08AFT	I	C	AND
IC405	XZ349A00	IC	CS8405A-CS	I	C	DIT
IC406	XV930A00	IC	SN75124NSR	I	C	LINE RECEIVER
IC407	X2485200	IC	M37641M8-141FP	I	C	CPU (USB 32K)
* IC408	V9924900	Photo Coupler	PC410L0NIP	フ ォ ト カ プ ラ		09
IC501	X0195A00	IC	TC74VHC04FT	I	C	INVERTER
* IC502	X4069A00	IC	S-80145ANMC-JC6-T2	I	C	SYSTEM RESET
IC601	XF291A00	IC	UPC4570G2	I	C	OP AMP
IC602	XF291A00	IC	UPC4570G2	I	C	OP AMP
IC603	X3447A00	IC	CS5361-KS	I	C	ADC
IC605	XS775A00	IC	TC7SH04FU	I	C	INVERTER
IC606	XT744A00	IC	TC74VHCT245AFT	I	C	TRANSCEIVER
IC651	XF291A00	IC	UPC4570G2	I	C	OP AMP

*: New Parts

RANK: Japan only

REF NO.	PART NO.	DESCRIPTION	部 品 名	REMARKS	QTY	RANK
IC652	XF291A00	IC	UPC4570G2	I C	OP AMP	03
IC701	XW029A00	IC	AK4393-VF-E2	I C	DAC	07
IC702	XJ598A00	IC	NJM78L05UA	I C	REGULATOR +5V	02
IC703	XF291A00	IC	UPC4570G2	I C	OP AMP	03
IC704	XP844A00	IC	NJM4556AL	I C	OP AMP	02
IC753	XF291A00	IC	UPC4570G2	I C	OP AMP	03
IC754	XP844A00	IC	NJM4556AL	I C	OP AMP	02
* IC801	X3942A00	IC	NJM78M15DL1A	I C	REGULATOR +15V	
* IC802	X3943A00	IC	NJM79M15DL1A	I C	REGULATOR -15V	
IC803	XS534A00	IC	NJM78M05DL1A(TE1)	I C	REGULATOR +5V	02
IC804	X2589A00	IC	PQ033Y3H3ZP	I C	REGULATOR +3.3V	04
JK401	V9234300	Cannon Connector	NC3FBH1	キ ャ ノ ン コ ネ ク タ	AES/EBU IN	06
JK402	VS133700	Cannon Connector	NC3MAH	キ ャ ノ ン コ ネ ク タ	AES/EBU OUT	04
JK403	V6415900	BNC Connector	1P YKS11-0067	1 P B N C コ ネ ク タ	WORD CLOCK IN	05
JK404	VK519000	DIN Connector	5P3 YKF51-50	D I N コ ネ ク タ 2 連	MIDI IN,OUT/THRU	04
JK601	V9234300	Cannon Connector	NC3FBH1	キ ャ ノ ン コ ネ ク タ	INPUT L	06
JK651	V9234300	Cannon Connector	NC3FBH1	キ ャ ノ ン コ ネ ク タ	INPUT R	06
JK701	VS133700	Cannon Connector	NC3MAH	キ ャ ノ ン コ ネ ク タ	OUTPUT L	04
JK751	VS133700	Cannon Connector	NC3MAH	キ ャ ノ ン コ ネ ク タ	OUTPUT R	04
K401	V7539800	Cannon Angle		キ ャ ノ ン 金 具 (横 形)		02
K402	V7539800	Cannon Angle		キ ャ ノ ン 金 具 (横 形)		02
K601	V7539800	Cannon Angle		キ ャ ノ ン 金 具 (横 形)		02
K651	V7539800	Cannon Angle		キ ャ ノ ン 金 具 (横 形)		02
K701	V7539800	Cannon Angle		キ ャ ノ ン 金 具 (横 形)		02
K751	V7539800	Cannon Angle		キ ャ ノ ン 金 具 (横 形)		02
K801	--	Heat Sink	PUE16-30	ヒ ー ト シ ン ク	(WB08520)	
L001	GE300610	Ferrite Bead	BL02RN1-R62T4	フ ェ ラ イ ト ビ ー ズ		01
L003	VP246300	Noise Filter	ZJY51R5-2P	ノ イ ズ フ ィ ル タ ー		04
L201	GE300610	Ferrite Bead	BL02RN1-R62T4	フ ェ ラ イ ト ビ ー ズ		01
L202	V7716400	Coil	SSB44-331 330uH	コ イ ル 3 3 0 U		03
L401	GE300610	Ferrite Bead	BL02RN1-R62T4	フ ェ ラ イ ト ビ ー ズ		01
-405	GE300610	Ferrite Bead	BL02RN1-R62T4	フ ェ ラ イ ト ビ ー ズ		01
L406	V7930100	Pulse Transformer	TB06A015	パ ル ス ト ラ ン ス		05
L407	V7930100	Pulse Transformer	TB06A015	パ ル ス ト ラ ン ス		05
L408	VP246300	Noise Filter	ZJY51R5-2P	ノ イ ズ フ ィ ル タ ー		04
L410	VB835000	Ferrite Bead	FL5R200QNT 20uH	コ イ ル 2 0 U		01
-413	VB835000	Ferrite Bead	FL5R200QNT 20uH	コ イ ル 2 0 U		01
L414	V5239100	Common Mode Coil	DLP31SN121SL2L	コ モ ン モ ー ド コ イ ル		03
R001	RD356300	Carbon Resistor (chip)	3.0K 63M J	チ ッ プ 抵 抗		01
R002	RD357100	Carbon Resistor (chip)	10.0K 63M J	チ ッ プ 抵 抗		01
R003	RD356200	Carbon Resistor (chip)	2.0K 63M J	チ ッ プ 抵 抗		01
R004	RD355100	Carbon Resistor (chip)	100.0 63M J	チ ッ プ 抵 抗		01
R005	RD358100	Carbon Resistor (chip)	100.0K 63M J	チ ッ プ 抵 抗		01
R006	RD359100	Carbon Resistor (chip)	1.0M 63M J	チ ッ プ 抵 抗		01
R007	RD357100	Carbon Resistor (chip)	10.0K 63M J	チ ッ プ 抵 抗		01
R011	RD357100	Carbon Resistor (chip)	10.0K 63M J	チ ッ プ 抵 抗		01
R012	RD357100	Carbon Resistor (chip)	10.0K 63M J	チ ッ プ 抵 抗		01
R017	RD355220	Carbon Resistor (chip)	220.0 63M J	チ ッ プ 抵 抗		01
R020	RD357100	Carbon Resistor (chip)	10.0K 63M J	チ ッ プ 抵 抗		01
R021	RD357100	Carbon Resistor (chip)	10.0K 63M J	チ ッ プ 抵 抗		01
R022	RD350000	Carbon Resistor (chip)	0 63M J	チ ッ プ 抵 抗		01
R026	RD354330	Carbon Resistor (chip)	33.0 63M J	チ ッ プ 抵 抗		01
R027	RD354330	Carbon Resistor (chip)	33.0 63M J	チ ッ プ 抵 抗		01
R028	RD350000	Carbon Resistor (chip)	0 63M J	チ ッ プ 抵 抗		01
R029	RD357100	Carbon Resistor (chip)	10.0K 63M J	チ ッ プ 抵 抗		01
R030	RD356100	Carbon Resistor (chip)	1.0K 63M J	チ ッ プ 抵 抗		01
R033	RD354220	Carbon Resistor (chip)	22.0 63M J	チ ッ プ 抵 抗		01
R034	RD354100	Carbon Resistor (chip)	10.0 63M J	チ ッ プ 抵 抗		01
R035	RD354470	Carbon Resistor (chip)	47.0 63M J	チ ッ プ 抵 抗		01
-051	RD354470	Carbon Resistor (chip)	47.0 63M J	チ ッ プ 抵 抗		01
R052	RD350000	Carbon Resistor (chip)	0 63M J	チ ッ プ 抵 抗		01
-056	RD350000	Carbon Resistor (chip)	0 63M J	チ ッ プ 抵 抗		01
R102	RD355100	Carbon Resistor (chip)	100.0 63M J	チ ッ プ 抵 抗		01
R103	RD356330	Carbon Resistor (chip)	3.3K 63M J	チ ッ プ 抵 抗		01
R104	RD357100	Carbon Resistor (chip)	10.0K 63M J	チ ッ プ 抵 抗		01
-108	RD357100	Carbon Resistor (chip)	10.0K 63M J	チ ッ プ 抵 抗		01
R201	RD357100	Carbon Resistor (chip)	10.0K 63M J	チ ッ プ 抵 抗		01
-204	RD357100	Carbon Resistor (chip)	10.0K 63M J	チ ッ プ 抵 抗		01
R205	RD355100	Carbon Resistor (chip)	100.0 63M J	チ ッ プ 抵 抗		01
R206	RD350000	Carbon Resistor (chip)	0 63M J	チ ッ プ 抵 抗		01

*: New Parts

RANK: Japan only

REF NO.	PART NO.	DESCRIPTION	部 品 名	REMARKS	QTY	RANK
R209	RD355150	Carbon Resistor (chip)	150.0 63M J	チ ッ ブ 抵 抗		01
R210	RD356150	Carbon Resistor (chip)	1.5K 63M J	チ ッ ブ 抵 抗		01
R211	RD354680	Carbon Resistor (chip)	68.0 63M J	チ ッ ブ 抵 抗		01
-217	RD354680	Carbon Resistor (chip)	68.0 63M J	チ ッ ブ 抵 抗		01
R218	RD355100	Carbon Resistor (chip)	100.0 63M J	チ ッ ブ 抵 抗		01
R219	RD354470	Carbon Resistor (chip)	47.0 63M J	チ ッ ブ 抵 抗		01
R220	RD350000	Carbon Resistor (chip)	0 63M J	チ ッ ブ 抵 抗		01
R221	RD354470	Carbon Resistor (chip)	47.0 63M J	チ ッ ブ 抵 抗		01
R222	RD354680	Carbon Resistor (chip)	68.0 63M J	チ ッ ブ 抵 抗		01
R223	RD354470	Carbon Resistor (chip)	47.0 63M J	チ ッ ブ 抵 抗		01
-225	RD354470	Carbon Resistor (chip)	47.0 63M J	チ ッ ブ 抵 抗		01
R226	V1194600	Metal Film Resistor (chip)	750.0 1/10 D	チ ッ ブ 金 被 抵 抗		01
R227	V1196100	Metal Film Resistor (chip)	3.3K 1/10 D	チ ッ ブ 金 被 抵 抗		01
R228	V1196100	Metal Film Resistor (chip)	3.3K 1/10 D	チ ッ ブ 金 被 抵 抗		01
R229	V1193700	Metal Film Resistor (chip)	330.0 1/10 D	チ ッ ブ 金 被 抵 抗		01
R230	V1196000	Metal Film Resistor (chip)	3.0K 1/10 D	チ ッ ブ 金 被 抵 抗		01
R231	RD350000	Carbon Resistor (chip)	0 63M J	チ ッ ブ 抵 抗		01
-235	RD350000	Carbon Resistor (chip)	0 63M J	チ ッ ブ 抵 抗		01
R236	RD355100	Carbon Resistor (chip)	100.0 63M J	チ ッ ブ 抵 抗		01
R237	RD354680	Carbon Resistor (chip)	68.0 63M J	チ ッ ブ 抵 抗		01
R238	RD350000	Carbon Resistor (chip)	0 63M J	チ ッ ブ 抵 抗		01
-241	RD350000	Carbon Resistor (chip)	0 63M J	チ ッ ブ 抵 抗		01
R301	RD354470	Carbon Resistor (chip)	47.0 63M J	チ ッ ブ 抵 抗		01
R302	RD350000	Carbon Resistor (chip)	0 63M J	チ ッ ブ 抵 抗		01
R401	RD354470	Carbon Resistor (chip)	47.0 63M J	チ ッ ブ 抵 抗		01
R402	V1196400	Metal Film Resistor (chip)	3.9K 1/10 D	チ ッ ブ 金 被 抵 抗		01
R403	RD354470	Carbon Resistor (chip)	47.0 63M J	チ ッ ブ 抵 抗		01
R404	RD357470	Carbon Resistor (chip)	47.0K 63M J	チ ッ ブ 抵 抗		01
-406	RD357470	Carbon Resistor (chip)	47.0K 63M J	チ ッ ブ 抵 抗		01
R408	RD350000	Carbon Resistor (chip)	0 63M J	チ ッ ブ 抵 抗		01
R409	RD357100	Carbon Resistor (chip)	10.0K 63M J	チ ッ ブ 抵 抗		01
R410	RD357100	Carbon Resistor (chip)	10.0K 63M J	チ ッ ブ 抵 抗		01
R411	RD356560	Carbon Resistor (chip)	5.6K 63M J	チ ッ ブ 抵 抗		01
R412	RD356470	Carbon Resistor (chip)	4.7K 63M J	チ ッ ブ 抵 抗		01
R413	RD356100	Carbon Resistor (chip)	1.0K 63M J	チ ッ ブ 抵 抗		01
R414	RD356100	Carbon Resistor (chip)	1.0K 63M J	チ ッ ブ 抵 抗		01
R415	RD356220	Carbon Resistor (chip)	2.2K 63M J	チ ッ ブ 抵 抗		01
R416	RD355110	Carbon Resistor (chip)	110.0 63M J	チ ッ ブ 抵 抗		01
R417	RD355110	Carbon Resistor (chip)	110.0 63M J	チ ッ ブ 抵 抗		01
R418	RD355680	Carbon Resistor (chip)	680.0 63M J	チ ッ ブ 抵 抗		01
R419	RD357220	Carbon Resistor (chip)	22.0K 63M J	チ ッ ブ 抵 抗		01
R420	RD254470	Carbon Resistor (chip)	47.0 0.1 J	チ ッ ブ 抵 抗		01
R421	RD357220	Carbon Resistor (chip)	22.0K 63M J	チ ッ ブ 抵 抗		01
R422	RD254750	Carbon Resistor (chip)	75.0 0.1 J	チ ッ ブ 抵 抗		01
R423	RD355220	Carbon Resistor (chip)	220.0 63M J	チ ッ ブ 抵 抗		01
R424	RD154330	Carbon Resistor (chip)	33.0 1/4 J	チ ッ ブ 抵 抗		01
R425	RD154330	Carbon Resistor (chip)	33.0 1/4 J	チ ッ ブ 抵 抗		01
R426	RD356150	Carbon Resistor (chip)	1.5K 63M J	チ ッ ブ 抵 抗		01
R427	RD354470	Carbon Resistor (chip)	47.0 63M J	チ ッ ブ 抵 抗		01
R428	RD354470	Carbon Resistor (chip)	47.0 63M J	チ ッ ブ 抵 抗		01
R501	RD154330	Carbon Resistor (chip)	33.0 1/4 J	チ ッ ブ 抵 抗		01
-510	RD154330	Carbon Resistor (chip)	33.0 1/4 J	チ ッ ブ 抵 抗		01
R511	RD357100	Carbon Resistor (chip)	10.0K 63M J	チ ッ ブ 抵 抗		01
R512	RD355220	Carbon Resistor (chip)	220.0 63M J	チ ッ ブ 抵 抗		01
R513	RD155150	Carbon Resistor (chip)	150.0 1/4 J	チ ッ ブ 抵 抗		01
R514	RD155180	Carbon Resistor (chip)	180.0 1/4 J	チ ッ ブ 抵 抗		01
R515	RD155180	Carbon Resistor (chip)	180.0 1/4 J	チ ッ ブ 抵 抗		01
R516	RD357100	Carbon Resistor (chip)	10.0K 63M J	チ ッ ブ 抵 抗		01
R517	RD357100	Carbon Resistor (chip)	10.0K 63M J	チ ッ ブ 抵 抗		01
R518	RD356100	Carbon Resistor (chip)	1.0K 63M J	チ ッ ブ 抵 抗		01
R519	RD356100	Carbon Resistor (chip)	1.0K 63M J	チ ッ ブ 抵 抗		01
R520	RD357100	Carbon Resistor (chip)	10.0K 63M J	チ ッ ブ 抵 抗		01
R521	RD357100	Carbon Resistor (chip)	10.0K 63M J	チ ッ ブ 抵 抗		01
R601	HF757820	Carbon Resistor	82.0K 1/4 J	力 ー ボ ン 抵 抗		01
R602	HF757820	Carbon Resistor	82.0K 1/4 J	力 ー ボ ン 抵 抗		01
R603	VC328800	Metal Film Resistor	10.0K 1/4 F	金 属 被 膜 抵 抗		01
R604	VC328800	Metal Film Resistor	10.0K 1/4 F	金 属 被 膜 抵 抗		01
R605	VC328500	Metal Film Resistor	7.5K 1/4 F	金 属 被 膜 抵 抗		01
* R606	HF758750	Carbon Resistor	750.0K 1/4 J	力 ー ボ ン 抵 抗		01
* R607	VC329900	Metal Film Resistor	30.0K 1/4 F	金 属 被 膜 抵 抗		01

*: New Parts

RANK: Japan only

REF NO.	PART NO.	DESCRIPTION		部 品 名	REMARKS	QTY	RANK
R608	VC328500	Metal Film Resistor	7.5K 1/4 F	金 属 被 膜 抵 抗			01
* R609	VC329900	Metal Film Resistor	30.0K 1/4 F	金 属 被 膜 抵 抗			01
R610	HF754390	Carbon Resistor	39.0 1/4 J	力 ー ボ ン 抵 抗			01
* R611	HF758750	Carbon Resistor	750.0K 1/4 J	力 ー ボ ン 抵 抗			01
R612	VC330600	Metal Film Resistor	56.0K 1/4 F	金 属 被 膜 抵 抗			01
R613	HF754390	Carbon Resistor	39.0 1/4 J	力 ー ボ ン 抵 抗			01
R614	VC328000	Metal Film Resistor	4.7K 1/4 F	金 属 被 膜 抵 抗			01
R615	VC328800	Metal Film Resistor	10.0K 1/4 F	金 属 被 膜 抵 抗			01
R616	VC329600	Metal Film Resistor	22.0K 1/4 F	金 属 被 膜 抵 抗			01
R617	VC327400	Metal Film Resistor	2.7K 1/4 F	金 属 被 膜 抵 抗			01
R618	VC327500	Metal Film Resistor	3.0K 1/4 F	金 属 被 膜 抵 抗			01
R619	VC327200	Metal Film Resistor	2.2K 1/4 F	金 属 被 膜 抵 抗			01
R620	VC326500	Metal Film Resistor	1.0K 1/4 F	金 属 被 膜 抵 抗			01
R621	VC327200	Metal Film Resistor	2.2K 1/4 F	金 属 被 膜 抵 抗			01
R622	HF755150	Carbon Resistor	150.0 1/4 J	力 ー ボ ン 抵 抗			01
R623	HF755150	Carbon Resistor	150.0 1/4 J	力 ー ボ ン 抵 抗			01
R624	VC329600	Metal Film Resistor	22.0K 1/4 F	金 属 被 膜 抵 抗			01
R625	VC326800	Metal Film Resistor	1.5K 1/4 F	金 属 被 膜 抵 抗			01
R626	VC328000	Metal Film Resistor	4.7K 1/4 F	金 属 被 膜 抵 抗			01
R629	RD350000	Carbon Resistor (chip)	0 63M J	チ ッ プ 抵 抗			01
R630	RD354470	Carbon Resistor (chip)	47.0 63M J	チ ッ プ 抵 抗			01
-632	RD354470	Carbon Resistor (chip)	47.0 63M J	チ ッ プ 抵 抗			01
R633	RD350000	Carbon Resistor (chip)	0 63M J	チ ッ プ 抵 抗			01
R634	RD354470	Carbon Resistor (chip)	47.0 63M J	チ ッ プ 抵 抗			01
R635	RD354470	Carbon Resistor (chip)	47.0 63M J	チ ッ プ 抵 抗			01
R636	RD355100	Carbon Resistor (chip)	100.0 63M J	チ ッ プ 抵 抗			01
R637	RD354470	Carbon Resistor (chip)	47.0 63M J	チ ッ プ 抵 抗			01
R638	RD355100	Carbon Resistor (chip)	100.0 63M J	チ ッ プ 抵 抗			01
R639	RD355100	Carbon Resistor (chip)	100.0 63M J	チ ッ プ 抵 抗			01
R640	RD357100	Carbon Resistor (chip)	10.0K 63M J	チ ッ プ 抵 抗			01
R641	RD357100	Carbon Resistor (chip)	10.0K 63M J	チ ッ プ 抵 抗			01
R642	VI199500	Metal Film Resistor (chip)	75.0K 1/10 D	チ ッ プ 金 被 抵 抗			01
-645	VI199500	Metal Film Resistor (chip)	75.0K 1/10 D	チ ッ プ 金 被 抵 抗			01
* R646	HF758750	Carbon Resistor	750.0K 1/4 J	力 ー ボ ン 抵 抗			01
R651	HF757820	Carbon Resistor	82.0K 1/4 J	力 ー ボ ン 抵 抗			01
R652	HF757820	Carbon Resistor	82.0K 1/4 J	力 ー ボ ン 抵 抗			01
R653	VC328800	Metal Film Resistor	10.0K 1/4 F	金 属 被 膜 抵 抗			01
R654	VC328800	Metal Film Resistor	10.0K 1/4 F	金 属 被 膜 抵 抗			01
R655	VC328500	Metal Film Resistor	7.5K 1/4 F	金 属 被 膜 抵 抗			01
* R656	HF758750	Carbon Resistor	750.0K 1/4 J	力 ー ボ ン 抵 抗			01
* R657	VC329900	Metal Film Resistor	30.0K 1/4 F	金 属 被 膜 抵 抗			01
R658	VC328500	Metal Film Resistor	7.5K 1/4 F	金 属 被 膜 抵 抗			01
* R659	VC329900	Metal Film Resistor	30.0K 1/4 F	金 属 被 膜 抵 抗			01
R660	HF754390	Carbon Resistor	39.0 1/4 J	力 ー ボ ン 抵 抗			01
* R661	HF758750	Carbon Resistor	750.0K 1/4 J	力 ー ボ ン 抵 抗			01
R662	VC330600	Metal Film Resistor	56.0K 1/4 F	金 属 被 膜 抵 抗			01
R663	HF754390	Carbon Resistor	39.0 1/4 J	力 ー ボ ン 抵 抗			01
R664	VC328000	Metal Film Resistor	4.7K 1/4 F	金 属 被 膜 抵 抗			01
R665	VC328800	Metal Film Resistor	10.0K 1/4 F	金 属 被 膜 抵 抗			01
R666	VC329600	Metal Film Resistor	22.0K 1/4 F	金 属 被 膜 抵 抗			01
R667	VC327400	Metal Film Resistor	2.7K 1/4 F	金 属 被 膜 抵 抗			01
R668	VC327200	Metal Film Resistor	2.2K 1/4 F	金 属 被 膜 抵 抗			01
R669	VC327500	Metal Film Resistor	3.0K 1/4 F	金 属 被 膜 抵 抗			01
R670	VC326500	Metal Film Resistor	1.0K 1/4 F	金 属 被 膜 抵 抗			01
R671	VC327200	Metal Film Resistor	2.2K 1/4 F	金 属 被 膜 抵 抗			01
R672	HF755150	Carbon Resistor	150.0 1/4 J	力 ー ボ ン 抵 抗			01
R673	HF755150	Carbon Resistor	150.0 1/4 J	力 ー ボ ン 抵 抗			01
R692	VI199500	Metal Film Resistor (chip)	75.0K 1/10 D	チ ッ プ 金 被 抵 抗			01
-695	VI199500	Metal Film Resistor (chip)	75.0K 1/10 D	チ ッ プ 金 被 抵 抗			01
* R696	HF758750	Carbon Resistor	750.0K 1/4 J	力 ー ボ ン 抵 抗			01
R701	RD354680	Carbon Resistor (chip)	68.0 63M J	チ ッ プ 抵 抗			01
R702	RD350000	Carbon Resistor (chip)	0 63M J	チ ッ プ 抵 抗			01
R703	RD355100	Carbon Resistor (chip)	100.0 63M J	チ ッ プ 抵 抗			01
R704	RD350000	Carbon Resistor (chip)	0 63M J	チ ッ プ 抵 抗			01
-706	RD350000	Carbon Resistor (chip)	0 63M J	チ ッ プ 抵 抗			01
R708	RD350000	Carbon Resistor (chip)	0 63M J	チ ッ プ 抵 抗			01
R709	VC326800	Metal Film Resistor	1.5K 1/4 F	金 属 被 膜 抵 抗			01
R710	VC326800	Metal Film Resistor	1.5K 1/4 F	金 属 被 膜 抵 抗			01
R711	VC328400	Metal Film Resistor	6.8K 1/4 F	金 属 被 膜 抵 抗			01
R713	VC326800	Metal Film Resistor	1.5K 1/4 F	金 属 被 膜 抵 抗			01

*: New Parts

RANK: Japan only

REF NO.	PART NO.	DESCRIPTION	部 品 名	REMARKS	QTY	RANK
R714	VC326800	Metal Film Resistor	1.5K 1/4 F	金 属 被 膜 抵 抗		
R715	VC328400	Metal Film Resistor	6.8K 1/4 F	金 属 被 膜 抵 抗		01
R717	HF754390	Carbon Resistor	39.0 1/4 J	力 一 ボ ン 抵 抗		01
R718	VC328700	Metal Film Resistor	9.1K 1/4 F	金 属 被 膜 抵 抗		01
R719	VC327200	Metal Film Resistor	2.2K 1/4 F	金 属 被 膜 抵 抗		01
R721	VC326500	Metal Film Resistor	1.0K 1/4 F	金 属 被 膜 抵 抗		01
R722	HF754390	Carbon Resistor	39.0 1/4 J	力 一 ボ ン 抵 抗		01
R723	VC328800	Metal Film Resistor	10.0K 1/4 F	金 属 被 膜 抵 抗		01
R724	VC328800	Metal Film Resistor	10.0K 1/4 F	金 属 被 膜 抵 抗		01
R725	VC328900	Metal Film Resistor	11.0K 1/4 F	金 属 被 膜 抵 抗		01
* R726	VC323700	Metal Film Resistor	82.00 1/4 F	金 属 被 膜 抵 抗		
R727	VC328800	Metal Film Resistor	10.0K 1/4 F	金 属 被 膜 抵 抗		01
R728	VC329500	Metal Film Resistor	20.0K 1/4 F	金 属 被 膜 抵 抗		01
R729	VC329500	Metal Film Resistor	20.0K 1/4 F	金 属 被 膜 抵 抗		01
R730	VC329400	Metal Film Resistor	18.0K 1/4 F	金 属 被 膜 抵 抗		01
R731	VC329400	Metal Film Resistor	18.0K 1/4 F	金 属 被 膜 抵 抗		01
R732	VC323600	Metal Film Resistor	75.00 1/4 F	金 属 被 膜 抵 抗		01
R733	VC323600	Metal Film Resistor	75.00 1/4 F	金 属 被 膜 抵 抗		01
R734	HF757470	Carbon Resistor	47.0K 1/4 J	力 一 ボ ン 抵 抗		01
R735	HF757470	Carbon Resistor	47.0K 1/4 J	力 一 ボ ン 抵 抗		01
R736	RD256680	Carbon Resistor (chip)	6.8K 0.1 J	チ ッ プ 抵 抗		01
R737	RD256680	Carbon Resistor (chip)	6.8K 0.1 J	チ ッ プ 抵 抗		01
R738	RD257100	Carbon Resistor (chip)	10.0K 0.1 J	チ ッ プ 抵 抗		01
R739	RD257330	Carbon Resistor (chip)	33.0K 0.1 J	チ ッ プ 抵 抗		01
R740	RD258100	Carbon Resistor (chip)	100.0K 0.1 J	チ ッ プ 抵 抗		01
R741	RD258100	Carbon Resistor (chip)	100.0K 0.1 J	チ ッ プ 抵 抗		01
R746	VC327400	Metal Film Resistor	2.7K 1/4 F	金 属 被 膜 抵 抗		01
R747	VC327400	Metal Film Resistor	2.7K 1/4 F	金 属 被 膜 抵 抗		01
R759	VC326800	Metal Film Resistor	1.5K 1/4 F	金 属 被 膜 抵 抗		
R760	VC326800	Metal Film Resistor	1.5K 1/4 F	金 属 被 膜 抵 抗		
R761	VC328400	Metal Film Resistor	6.8K 1/4 F	金 属 被 膜 抵 抗		01
R763	VC326800	Metal Film Resistor	1.5K 1/4 F	金 属 被 膜 抵 抗		
R764	VC326800	Metal Film Resistor	1.5K 1/4 F	金 属 被 膜 抵 抗		
R765	VC328400	Metal Film Resistor	6.8K 1/4 F	金 属 被 膜 抵 抗		01
R767	HF754390	Carbon Resistor	39.0 1/4 J	力 一 ボ ン 抵 抗		01
R768	VC328700	Metal Film Resistor	9.1K 1/4 F	金 属 被 膜 抵 抗		01
R769	VC327200	Metal Film Resistor	2.2K 1/4 F	金 属 被 膜 抵 抗		01
R771	VC326500	Metal Film Resistor	1.0K 1/4 F	金 属 被 膜 抵 抗		01
R772	HF754390	Carbon Resistor	39.0 1/4 J	力 一 ボ ン 抵 抗		01
R773	VC328800	Metal Film Resistor	10.0K 1/4 F	金 属 被 膜 抵 抗		01
R774	VC328800	Metal Film Resistor	10.0K 1/4 F	金 属 被 膜 抵 抗		01
R775	VC328900	Metal Film Resistor	11.0K 1/4 F	金 属 被 膜 抵 抗		01
* R776	VC323700	Metal Film Resistor	82.00 1/4 F	金 属 被 膜 抵 抗		
R777	VC328800	Metal Film Resistor	10.0K 1/4 F	金 属 被 膜 抵 抗		01
R778	VC329500	Metal Film Resistor	20.0K 1/4 F	金 属 被 膜 抵 抗		01
R779	VC329500	Metal Film Resistor	20.0K 1/4 F	金 属 被 膜 抵 抗		01
R780	VC329400	Metal Film Resistor	18.0K 1/4 F	金 属 被 膜 抵 抗		01
R781	VC329400	Metal Film Resistor	18.0K 1/4 F	金 属 被 膜 抵 抗		01
R782	VC323600	Metal Film Resistor	75.00 1/4 F	金 属 被 膜 抵 抗		01
R783	VC323600	Metal Film Resistor	75.00 1/4 F	金 属 被 膜 抵 抗		01
R784	HF757470	Carbon Resistor	47.0K 1/4 J	力 一 ボ ン 抵 抗		01
R785	HF757470	Carbon Resistor	47.0K 1/4 J	力 一 ボ ン 抵 抗		01
R786	RD256680	Carbon Resistor (chip)	6.8K 0.1 J	チ ッ プ 抵 抗		01
R787	RD256680	Carbon Resistor (chip)	6.8K 0.1 J	チ ッ プ 抵 抗		01
R796	VC327400	Metal Film Resistor	2.7K 1/4 F	金 属 被 膜 抵 抗		01
R797	VC327400	Metal Film Resistor	2.7K 1/4 F	金 属 被 膜 抵 抗		01
R801	RD356100	Carbon Resistor (chip)	1.0K 63M J	チ ッ プ 抵 抗		01
R802	RD154680	Carbon Resistor (chip)	68.0 1/4 J	チ ッ プ 抵 抗		01
R803	RD155110	Carbon Resistor (chip)	110.0 1/4 J	チ ッ プ 抵 抗		01
R804	RD356270	Carbon Resistor (chip)	2.7K 63M J	チ ッ プ 抵 抗		01
R805	RD155110	Carbon Resistor (chip)	110.0 1/4 J	チ ッ プ 抵 抗		01
R806	RD354680	Carbon Resistor (chip)	68.0 63M J	チ ッ プ 抵 抗		01
R807	RD357100	Carbon Resistor (chip)	10.0K 63M J	チ ッ プ 抵 抗		01
R808	V1198800	Metal Film Resistor (chip)	39.0K 1/10 D	チ ッ プ 金 属 被 抵 抗		01
R809	V1199500	Metal Film Resistor (chip)	75.0K 1/10 D	チ ッ プ 金 属 被 抵 抗		01
-815	V1199500	Metal Film Resistor (chip)	75.0K 1/10 D	チ ッ プ 金 属 被 抵 抗		01
RA001	RE047100	Resistor Array	10KX4	抵 抗 ア レ イ		01
-025	RE047100	Resistor Array	10KX4	抵 抗 ア レ イ		01
RA101	RE047100	Resistor Array	10KX4	抵 抗 ア レ イ		01
-106	RE047100	Resistor Array	10KX4	抵 抗 ア レ イ		01

*: New Parts

RANK: Japan only

REF NO.	PART NO.	DESCRIPTION		部 品 名	REMARKS	QTY	RANK
RA201	RE047100	Resistor Array	10KX4	抵 抗 ア レ イ			01
RA401	RE047470	Resistor Array	47KX4	抵 抗 ア レ イ			01
RA402	RE047470	Resistor Array	47KX4	抵 抗 ア レ イ			01
RA501	RE047100	Resistor Array	10KX4	抵 抗 ア レ イ			01
SW601	V8190000	Slide Switch	SSSU141800	ス ラ イ ド S W	INPUT -10dBu/+4dBu		03
SW701	VU120200	Slide Switch	SSSU122-S09N0	ス ラ イ ド S W	OUTPUT -10dBu/+4dBu		01
* T801	WB440600	Inverter Transformer	19LDH-132	イ ン バ ー タ ト ラ ン ス			
TA501	V9615500	Transistor Array	TD62783AF(EL)	ト ラ ン ジ ス タ ア レ イ			
TA502	V9615500	Transistor Array	TD62783AF(EL)	ト ラ ン ジ ス タ ア レ イ			
TA503	VY703900	Transistor Array	TD62309F(EL)	ト ラ ン ジ ス タ ア レ イ			04
TA504	VY703900	Transistor Array	TD62309F(EL)	ト ラ ン ジ ス タ ア レ イ			04
TH801	VV458100	Protector Switch	RUE300 3.00A 30V	ポ リ ス イ ッ チ			03
TR001	V3033500	Digital Transistor	DTC143XKA TP	デ ジ タ ル ト ラ ン ジ ス タ			01
TR401	VV556400	Transistor	2SC2412K Q,R,S	ト ラ ン ジ ス タ			01
TR402	VV556400	Transistor	2SC2412K Q,R,S	ト ラ ン ジ ス タ			01
TR501	VV655400	Digital Transistor	DTC114EKA TP	デ ジ タ ル ト ラ ン ジ ス タ			01
-506	VV655400	Digital Transistor	DTC114EKA TP	デ ジ タ ル ト ラ ン ジ ス タ			01
TR701	V2993500	Transistor	2SD1979 S,T	ト ラ ン ジ ス タ			01
TR702	V2993500	Transistor	2SD1979 S,T	ト ラ ン ジ ス タ			01
TR703	VV655400	Digital Transistor	DTC114EKA TP	デ ジ タ ル ト ラ ン ジ ス タ			01
TR704	VV655400	Digital Transistor	DTC114EKA TP	デ ジ タ ル ト ラ ン ジ ス タ			01
TR705	VR936300	Transistor	2SA1576A T106	ト ラ ン ジ ス タ			01
TR751	V2993500	Transistor	2SD1979 S,T	ト ラ ン ジ ス タ			01
TR752	V2993500	Transistor	2SD1979 S,T	ト ラ ン ジ ス タ			01
TR801	VV925400	Transistor	2SC2712 GR	ト ラ ン ジ ス タ			01
TR802	V9702100	Transistor	2SC3709A O,Y	ト ラ ン ジ ス タ			03
X001	WA002000	Quartz Crystal Unit	11MHz MA-406	水 晶 振 動 子			02
X201	V8904500	Quartz Crystal Unit	49.152MHz DSO751SB	水 晶 発 振 器			
X202	V8904400	Quartz Crystal Unit	45.1584M DSO751SB	水 晶 発 振 器			
X301	VZ156100	Quartz Crystal Unit	60MHz DSO751S	水 晶 発 振 器			06
X401	VP864900	Quartz Crystal Unit	16MHz SMD-49	水 晶 振 動 子			04
ZD801	V9544100	Zener Diode	HZK3CTR 3.3V	ツ ェ ナ ー ダイ オ ード			01
ZD802	VK040100	Zener Diode	RLZ11B 11.0V	ツ ェ ナ ー ダイ オ ード			01
△	V5065200	AC Inlet	3P M1908-C	A C イ ン レ ッ ト 3 P			03
* △	WB448400	LCD	EW10212YMR	液 晶 デ ィ ス プ レ イ			
△	VN103500	Lithium Battery	CR2032	リ チ ウ ム 電 池			03
△	V9702900	Power Supply Unit	ZWS50AF-5/J	電 源 ユ ニ ッ ト			19

*: New Parts

RANK: Japan only

PROFESSIONAL MULTI-EFFECT PROCESSOR

SFX2000

CIRCUIT DIAGRAM

■ CONTENTS (目次)

BLOCK DIAGRAM (ブロックダイアグラム)	3
OVERALL CONNECTOR CIRCUIT DIAGRAM (総コネクタ接続回路図)	4
OVERALL CIRCUIT DIAGRAM (総回路図)	
MAIN (001-009)	5 - 13
PN1-3, POWER, JKIN, JKOUT, VOL, FOOTSW	14

Notation for Circuit Diagrams (回路図表記上の注意)

How to identify inter-sheet connectors (シート間コネクタの読み方について)

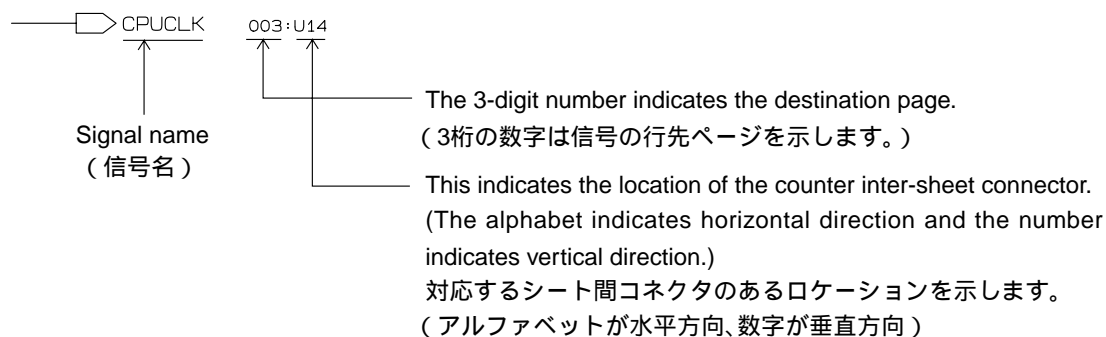

Note : See parts list for details of circuit board component parts.

注: シートの部品詳細は、パーツリストをご参照ください。

BLOCK DIAGRAM

SPX2000

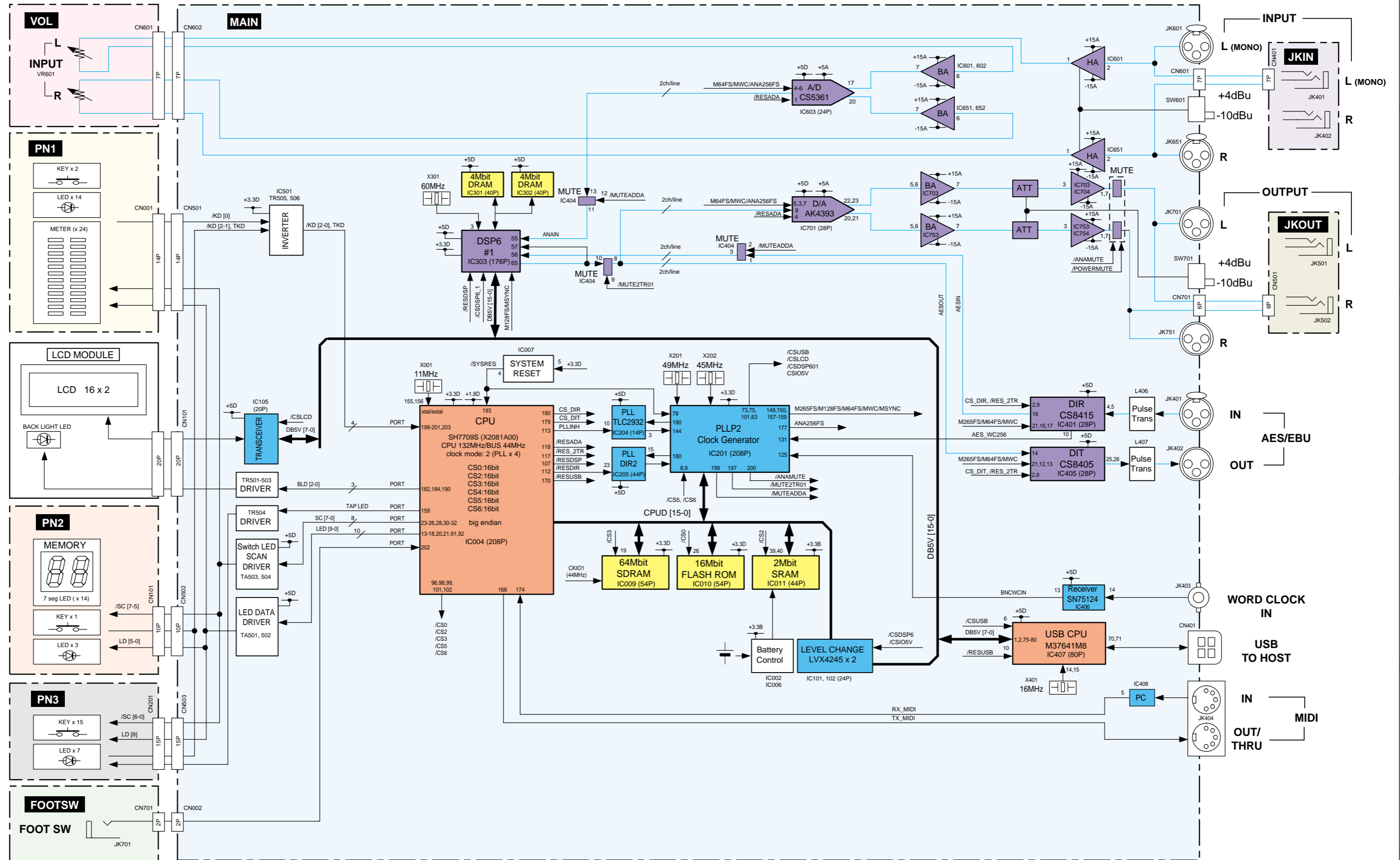

OVERALL CONNECTOR CIRCUIT DIAGRAM

SPX2000

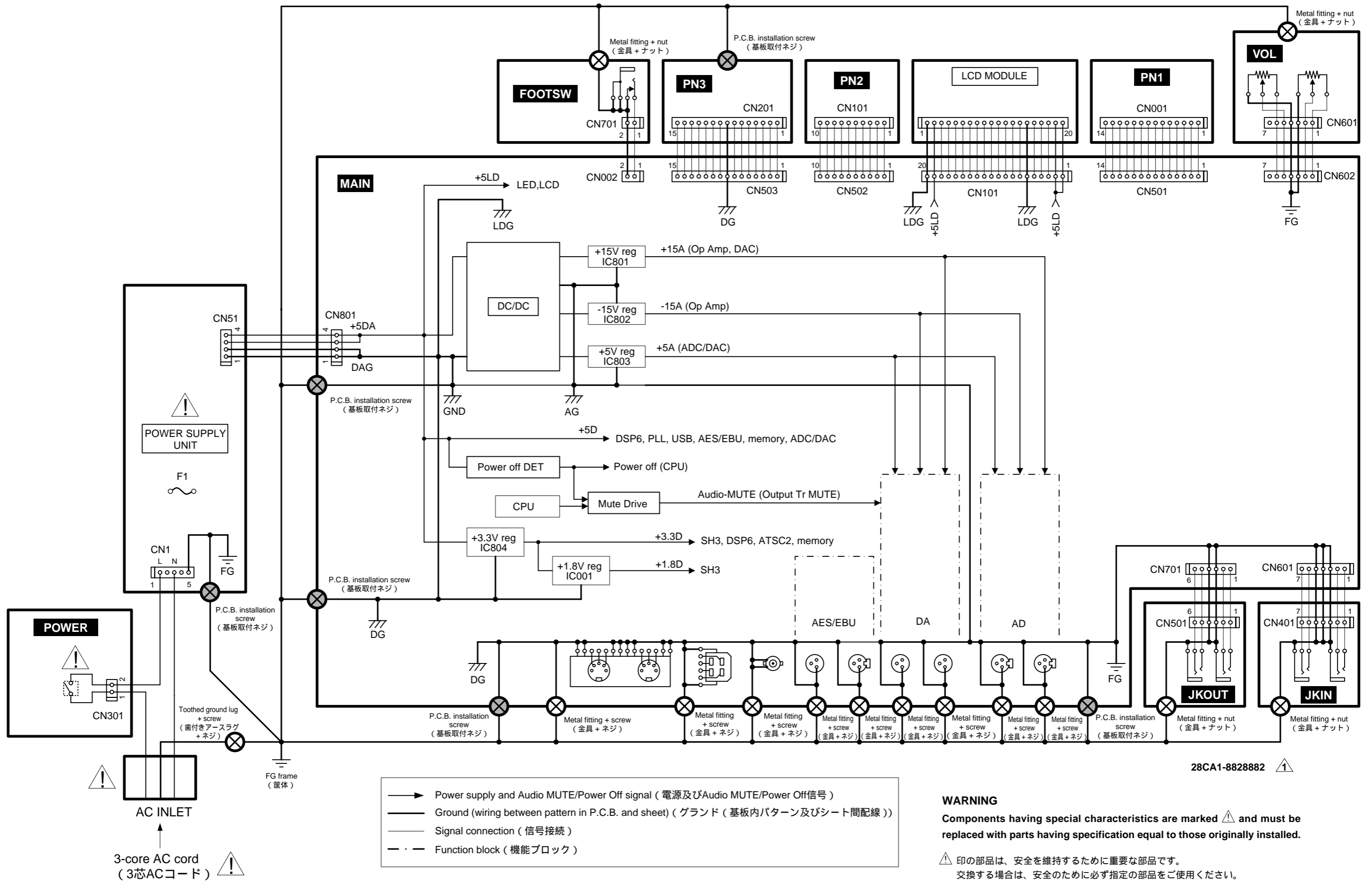

28CA1-882882 ⚠

OVERALL CIRCUIT DIAGRAM 001 (MAIN 1/9)

REGULATOR +1.8V

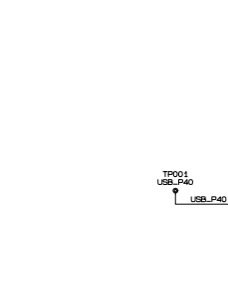
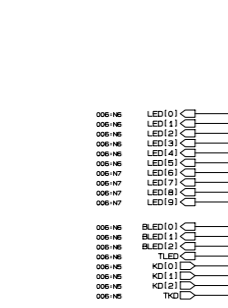
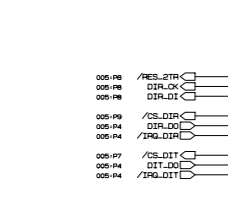
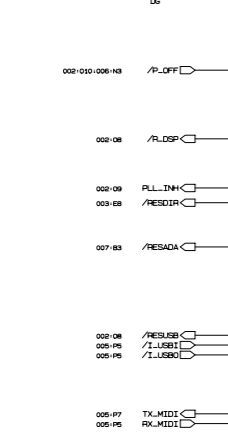
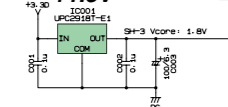

to FOOTSW-CN701

CPU

IC004 HD64177099F133

MODE: 2 CPU clock: 132MHz BUS clock: 44MHz CS0: 16bit CS1: 16bit CS2: 16bit CS3: 16bit CS4: 16bit CS5: 16bit CS6: 16bit (PCMCIA) Big endian

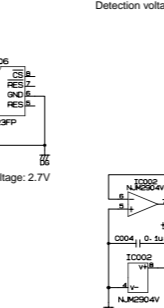
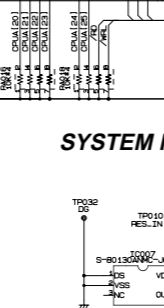
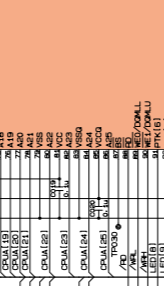

XX: not installed (未実装部品)

Battery VN10350

VN103600(Battery holder for VN103500)

- Notice for back-up battery removal. Push the battery as shown in figure, then the battery will pop up. Druk de batterij naar beneden zoals aangeven in de tekening, de batterij springt dan naar voren.

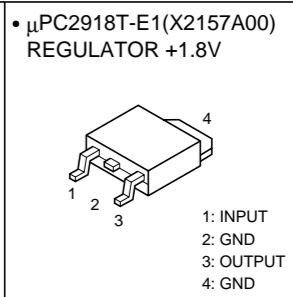
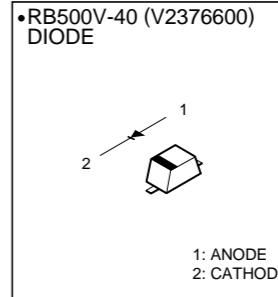
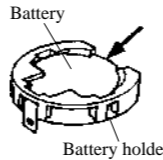

SDRAM 64M

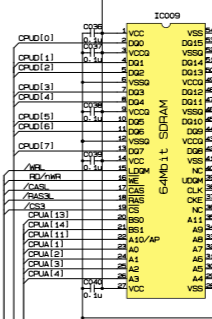

FLASH ROM 16M

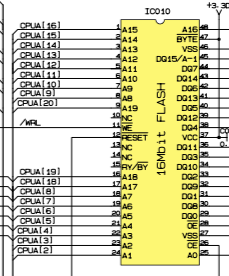

SYSTEM RESET

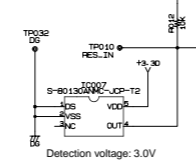

BATTERY CONTROL

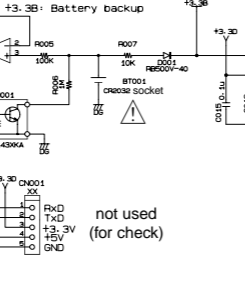

INVERTER

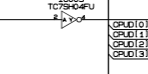

AND



OR



28CC1-8828883-1

OVERALL CIRCUIT DIAGRAM 002 (MAIN 2/9)

SPX2000

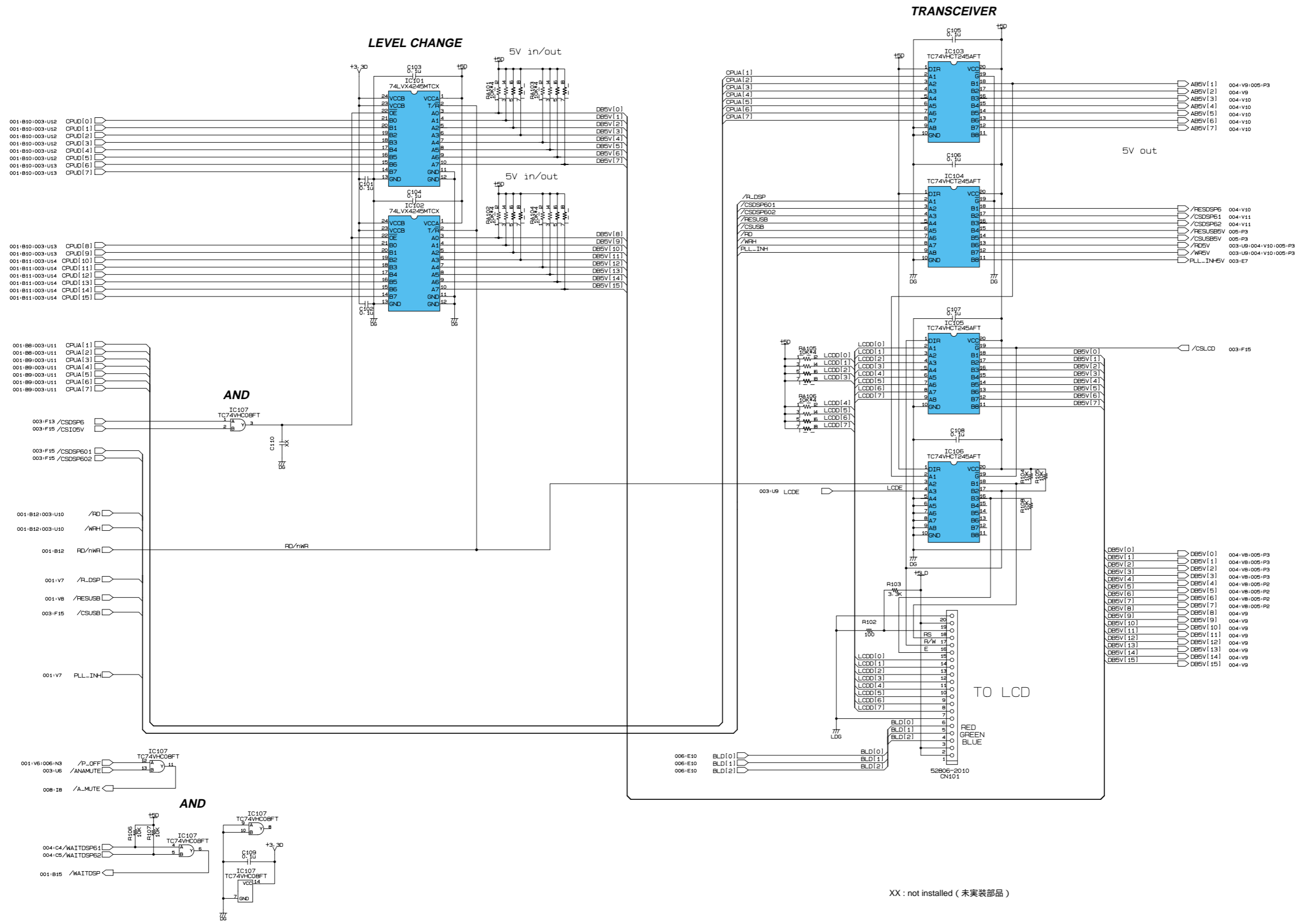

XX : not installed (未実装部品)

OVERALL CIRCUIT DIAGRAM 003 (MAIN 3/9)

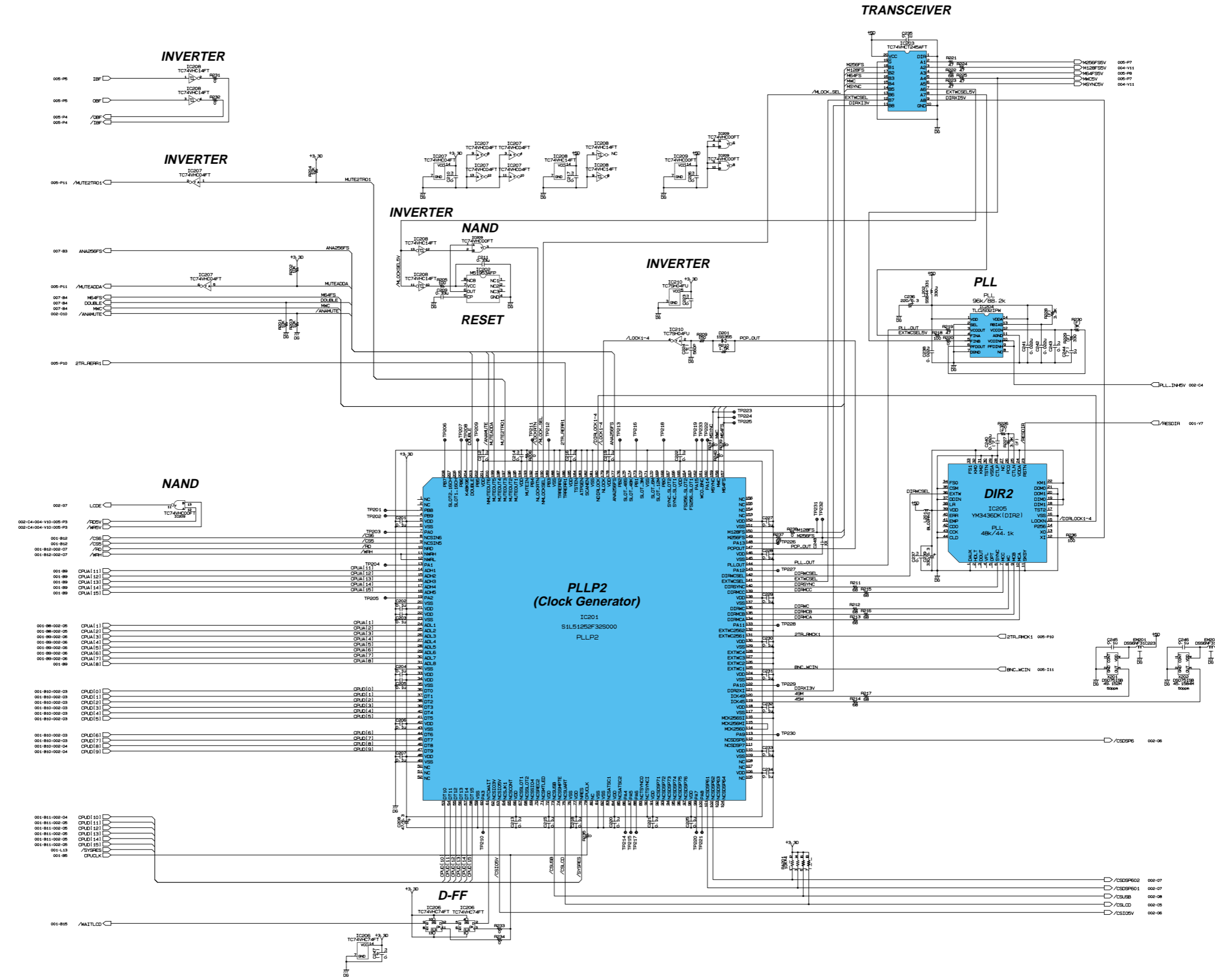

XX : not installed (未実装部品)
 (F) : Metal Film Resistor (金属皮膜抵抗)
 (マ) : Mylar Capacitor (マイラコンデンサ)
 (フ) : Film Capacitor (フィルムコンデンサ)
 (セ) : Ceramic Capacitor (セラミックコンデンサ)

OVERALL CIRCUIT DIAGRAM 004 (MAIN 4/9)

SPX2000

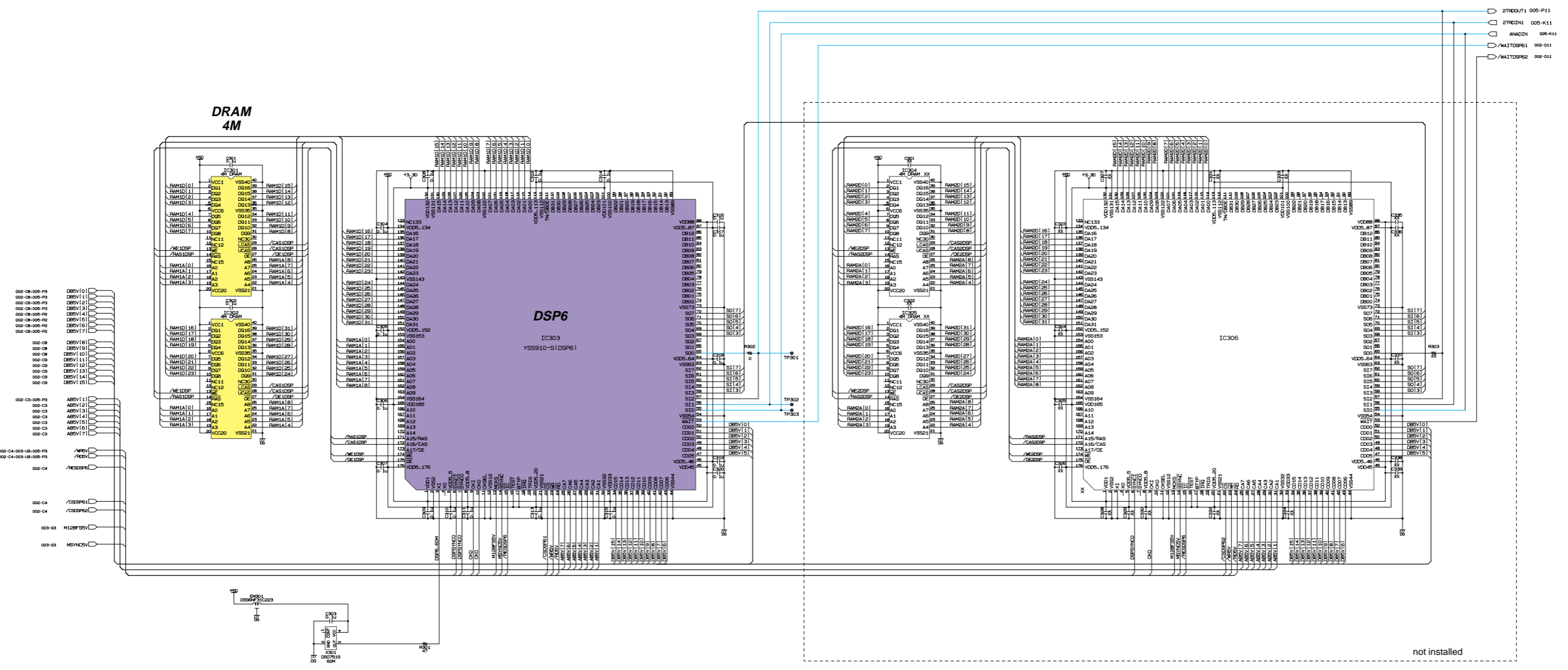

OVERALL CIRCUIT DIAGRAM 005 (MAIN 5/9)

SPX2000

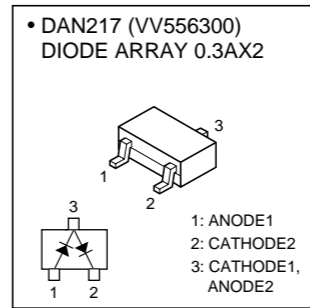
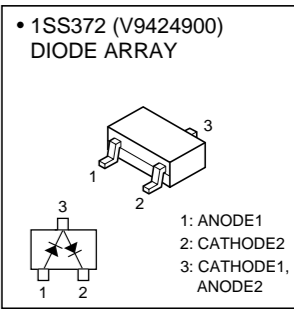
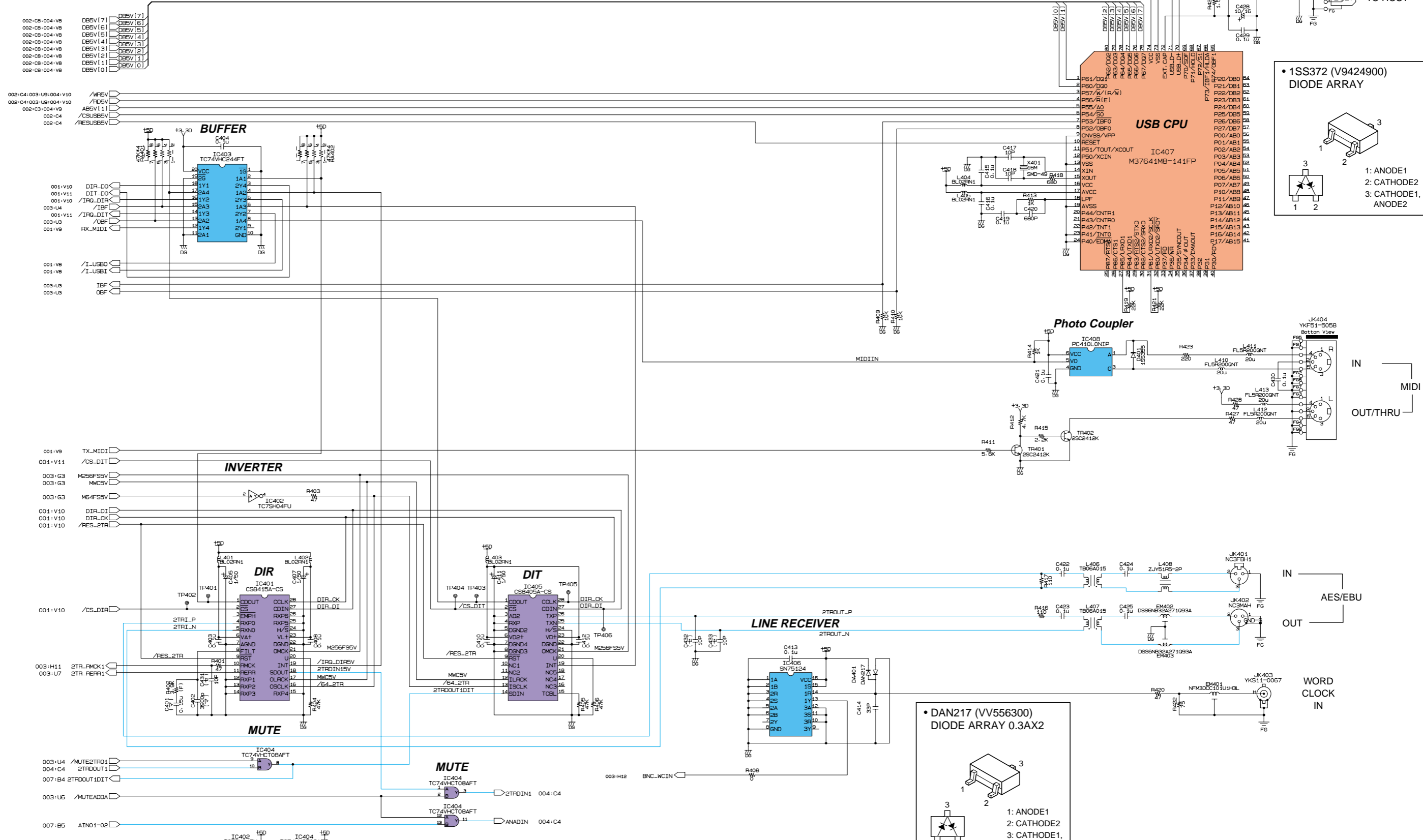

(F) : Metal Film Resistor (金属皮膜抵抗)
(マ) : Mylar Capacitor (マイラコンデンサ)
(セ) : Ceramic Capacitor (セラミックコンデンサ)

1
2
3
4
5
6
7
8
9
10
11
12

OVERALL CIRCUIT DIAGRAM 006 (MAIN 6/9)

SPX2000

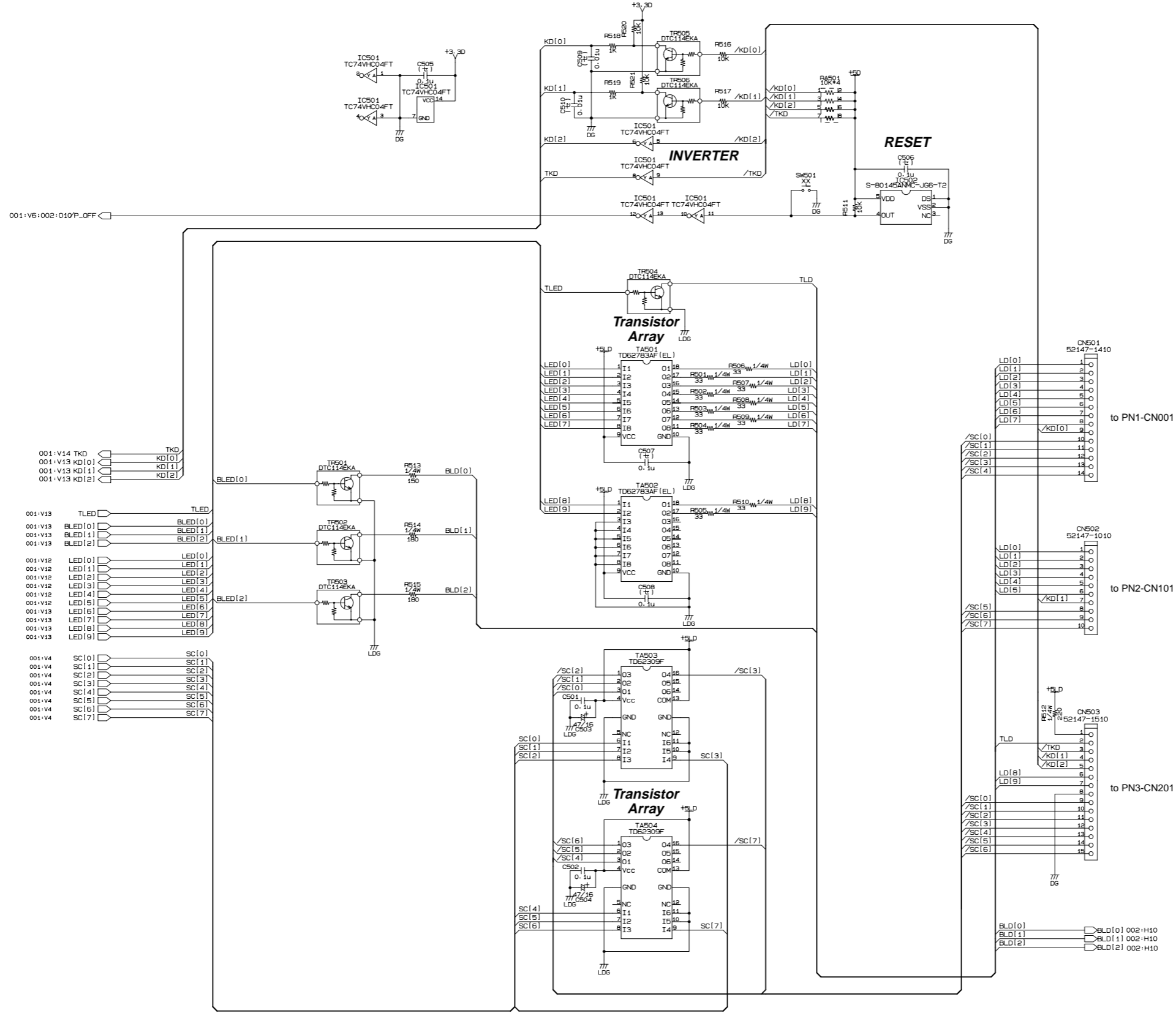

XX : not installed (未実装部品)
 (セ) : Ceramic Capacitor (セラミックコンデンサ)

OVERALL CIRCUIT DIAGRAM 006 (MAIN 6/9)

OVERALL CIRCUIT DIAGRAM 007 (MAIN 7/9)

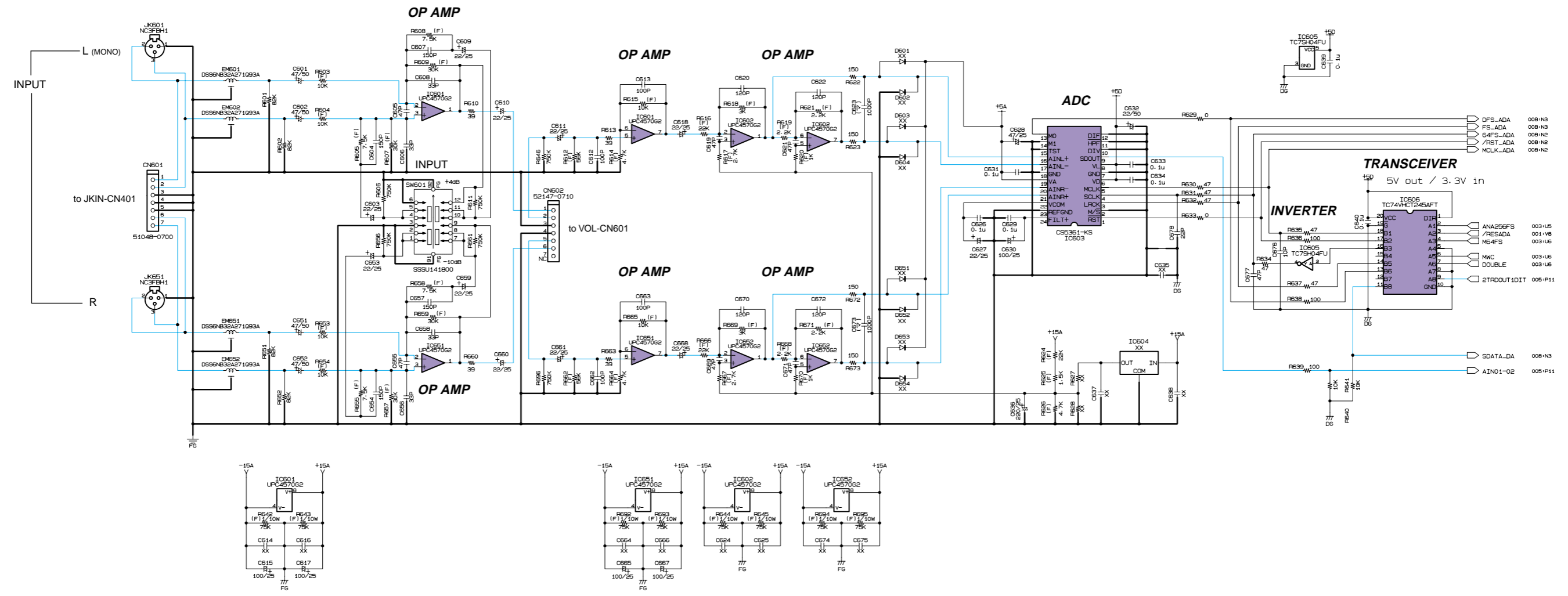

DFS_ADA	MCLK
H : Double Rate	128FS
L : Normal Rate	256FS

XX : not installed (未実装部品)
 (F) : Metal Film Resistor (金属皮膜抵抗)
 (マ) : Mylar Capacitor (マイラコンデンサ)

1
2
3
4
5
6
7
8
9
10
11
12

OVERALL CIRCUIT DIAGRAM 008 (MAIN 8/9)

SPX2000

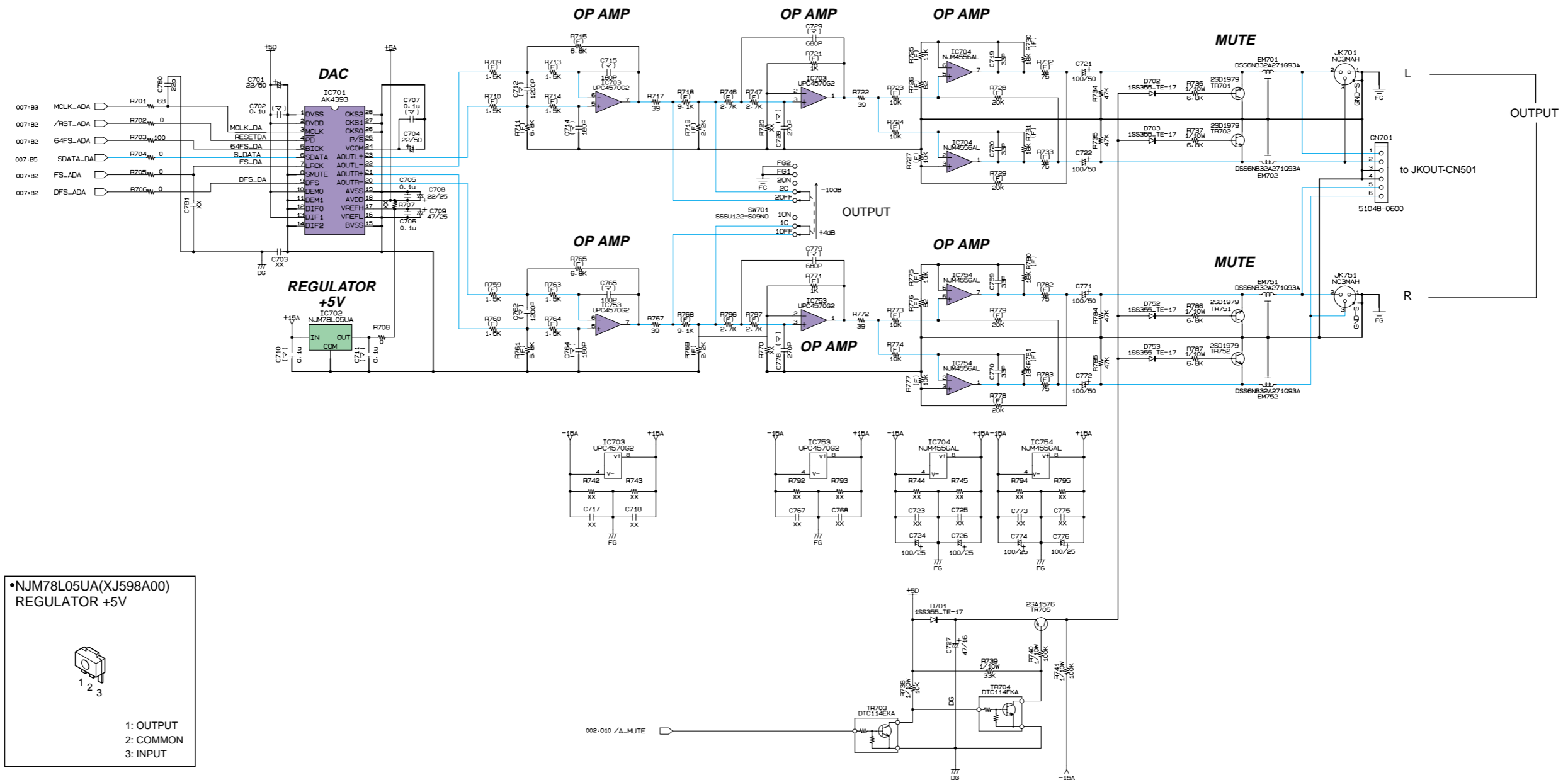

•NJM78L05UA(XJ598A00)
REGULATOR +5V

1: OUTPUT
2: COMMON
3: INPUT

DFS_ADA	MCLK
H : Double Rate	128FS
L : Normal Rate	256FS

XX : not installed (未実装部品)
(F) : Metal Film Resistor (金属皮膜抵抗)
(マ) : Mylar Capacitor (マイラコンデンサ)

OVERALL CIRCUIT DIAGRAM 008 (MAIN 8/9)

1
2
3
4
5
6
7
8
9
10
11
12

OVERALL CIRCUIT DIAGRAM 009 (MAIN 9/9)

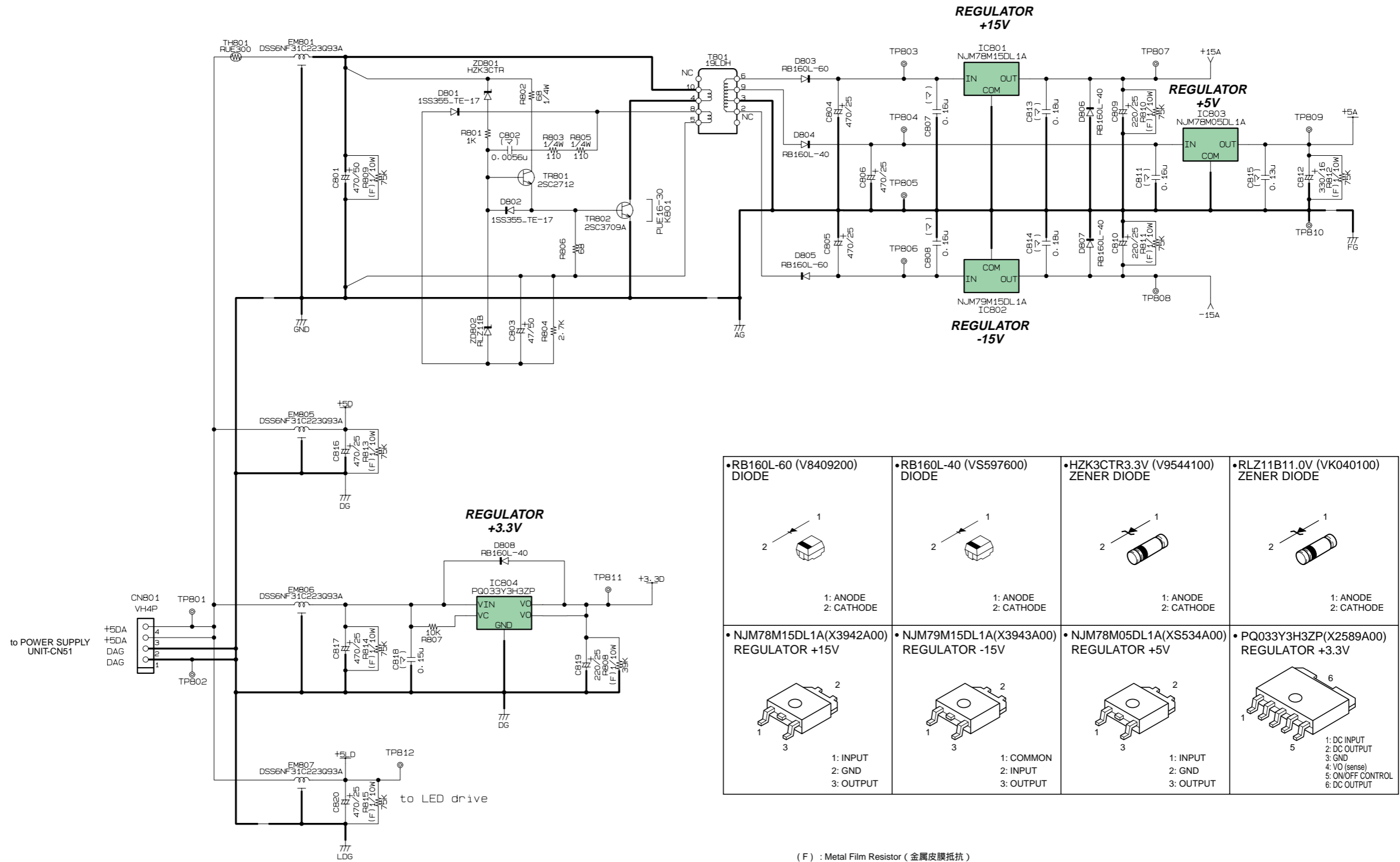

<ul style="list-style-type: none"> •RB160L-60 (V8409200) DIODE <p>1: ANODE 2: CATHODE</p>	<ul style="list-style-type: none"> •RB160L-40 (VS597600) DIODE <p>1: ANODE 2: CATHODE</p>	<ul style="list-style-type: none"> •HZK3CTR3.3V (V9544100) ZENER DIODE <p>1: ANODE 2: CATHODE</p>	<ul style="list-style-type: none"> •RLZ11B11.0V (VK040100) ZENER DIODE <p>1: ANODE 2: CATHODE</p>
<ul style="list-style-type: none"> •NJM78M15DL1A(X3942A00) REGULATOR +15V <p>1: INPUT 2: GND 3: OUTPUT</p>	<ul style="list-style-type: none"> •NJM79M15DL1A(X3943A00) REGULATOR -15V <p>1: COMMON 2: INPUT 3: OUTPUT</p>	<ul style="list-style-type: none"> •NJM78M05DL1A(XS534A00) REGULATOR +5V <p>1: INPUT 2: GND 3: OUTPUT</p>	<ul style="list-style-type: none"> •PQ033Y3H3ZP(X2589A00) REGULATOR +3.3V <p>1: DC INPUT 2: DC OUTPUT 3: GND 4: VO (sense) 5: ON/OFF CONTROL 6: DC OUTPUT</p>

(F) : Metal Film Resistor (金属皮膜抵抗)
 (マ) : Mylar Capacitor (マイラコンデンサ)

OVERALL CIRCUIT DIAGRAM (PN1-3, POWER, JKIN, JKOUT, VOL, FOOTSW)

SPX2000

1

2

3

4

5

6

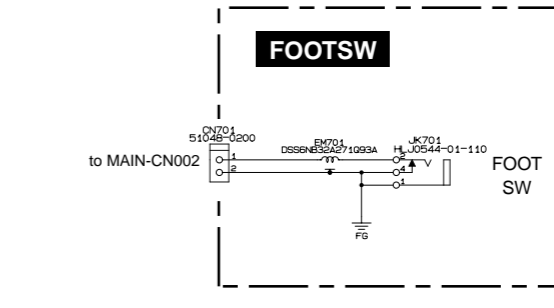
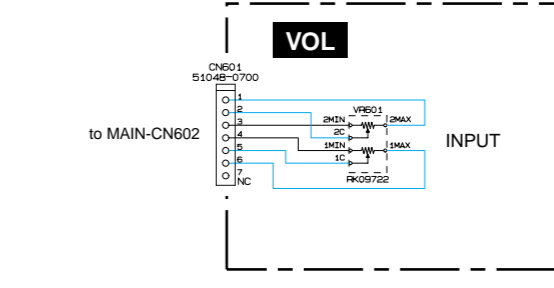
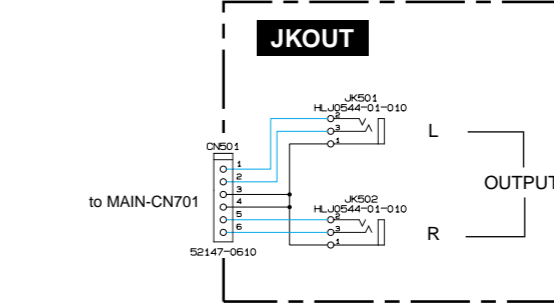
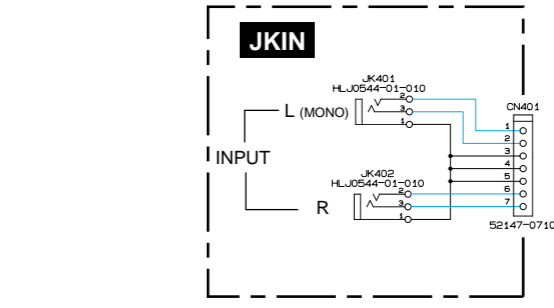
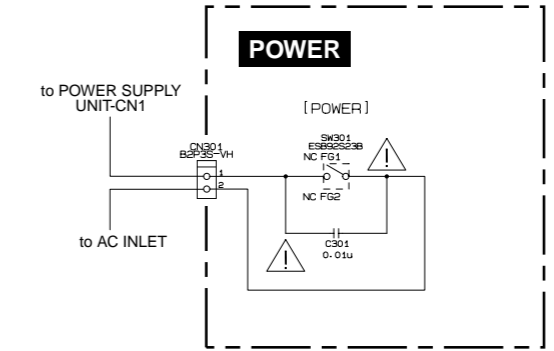
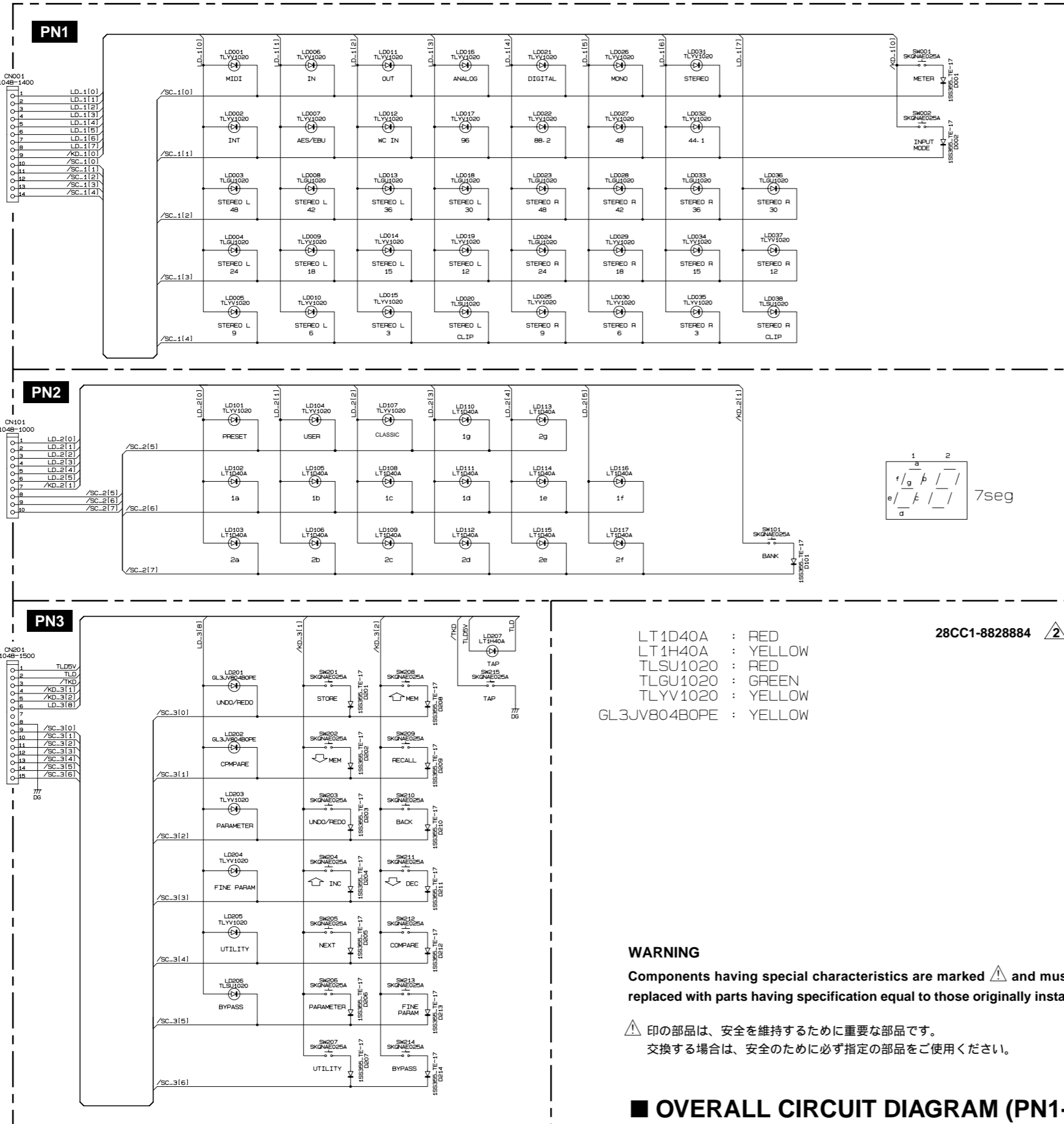

LT1D40A : RED
 LT1H40A : YELLOW
 TLSU1020 : RED
 TLGU1020 : GREEN
 TLYV1020 : YELLOW
 GL3JV804BOPE : YELLOW

28CC1-8828884 \triangle

WARNING
 Components having special characteristics are marked \triangle and must be replaced with parts having specification equal to those originally installed.

\triangle 印の部品は、安全を維持するために重要な部品です。
 交換する場合は、安全のために必ず指定の部品をご使用ください。

OVERALL CIRCUIT DIAGRAM (PN1-3, POWER, JKIN, JKOUT, VOL, FOOTSW)